

# Multi Variable Air Conditioners Duct Type Indoor Unit

## Owner's Manual Air Conditioners

Models:  
ATMI-224VRDC1A  
ATMI-280VRDC1A

- Thank you for choosing Air Conditioners, please read this owner's manual carefully before operation and retain it for future reference.



## Preface

For correct installation and operation, please read all instructions carefully. Before reading the instructions, please be aware of the following items:

- (1) For the safe operation of this unit, please read and follow the instructions carefully.
- (2) During operation, total capacity of indoor units should not exceed the total capacity of outdoor units. otherwise, poor effect of cooling or heating may result.
- (3) Direct operators or maintainers should well keep this manual.
- (4) If this unit fails to operate normally, please contact our service center as soon as possible and provide the following information:
  - Content on the nameplate(model number,cooling capacity,production code,ex-factory date.
  - Malfunction details(before and after the malfunction occurs.
- (5) Each unit has been strictly tested and proved to be qualified before ex-factory. In order to prevent units from being damaged or operating normally because of improper disassembly, please do not disassemble the unit by yourself. If you need to disassemble and check units, please contact our service center. We will send specialists to guide the disassembly.
- (6) All graphics in this manual is only for your reference. For sales or production reasons,these graphics are subject to change by manufacturer without prior notice.

## User Notice

- This appliance can be used by children aged from 8 years and above and persons with reduced physical, sensory or mental capabilities or lack of experience and knowledge if they have been given supervision or instruction concerning use of the appliance in a safe way and understand the hazards involved. Children shall not play with the appliance. Cleaning and user maintenance shall not be made by children without supervision.
- DISPOSAL: Do not dispose this product as unsorted municipal waste. Collection of such waste separately for special treatment is necessary.

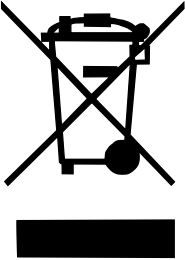
Correct Disposal of this product	
	<p>This marking indicates that this product should not be disposed with other household wastes throughout the EU. To prevent possible harm to the environment or human health from uncontrolled waste disposal, recycle it responsibly to promote the sustainable reuse of material resources. To return your used device, please use the return and collection systems or contact the retailer where the product was purchased. They can take this product for environmental safe recycling.</p>

# Contents

1 Safety Precautions .....	1
2 Product Introduction .....	3
2.1 Names of Key Components .....	3
2.2 Rated Working Condition .....	3
2.3 Unit Functions .....	3
3 Preparations for Installation .....	4
3.1 Standard Fittings .....	4
3.2 Location for Installation .....	5
3.3 Requirements for Communication Line .....	5
3.4 Wiring Requirements .....	6
4 Installation Instructions .....	7
4.1 Installation of Indoor Unit .....	7
4.2 Refrigerant Pipe Connection .....	9
4.3 Drainage Pipe Installation and Drainage System Testing .....	9
4.4 Installation of Air Duct .....	11
4.5 Installation of Wired Controller .....	13
4.6 External Static Pressure Settings .....	13
5 Wiring Work .....	14
5.1 Connection of Wire and Patch Board Terminal .....	14
5.2 Power Cord Connection .....	15
5.3 Connection of Communication Wire between Indoor Unit and Outdoor Unit(or indoor unit) ....	15
5.4 Connect Communication Wire of Wired Controller .....	15
5.5 Illuminate for Connection of Wired Controller and Indoor Units Network .....	16
6 Routine Maintenance .....	18
6.1 Cleaning of Filter .....	18
6.2 Maintenance before the Seasonal Use .....	18
6.3 Maintenance after the Seasonal Use .....	18
7 Table of Error Codes for Indoor Unit .....	19
8 Troubleshooting .....	19

# 1 Safety Precautions

 means items that must be forbidden! Otherwise, it may lead to personal injury or death or serious damage.

 means items that must be followed! Otherwise, it may lead to personal injury or property loss.



Follow this instruction to complete the installation work. Please carefully read this manual before unit startup and service.



Installation should be conducted by dealer or qualified personnel. Please do not attempt to install the unit by yourself. Improper handling may result in water leakage, electric shock or fire disaster etc.

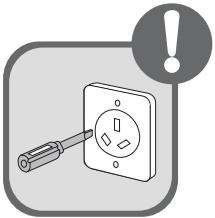

Before installation, please check if the power supply is in accordance with the requirements specified on the nameplate. And also take care of the power safety.

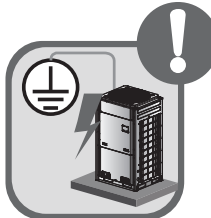

Make sure the unit can be earthed properly and soundly after plugging into the socket so as to avoid electric shock. Please do not connect the ground wire to gas pipe, water pipe, lightning rod or telephone line.



Be sure to use the exclusive accessory and part to prevent the water leakage, electric shock and fire accidents.



If refrigerant leakage happens during installation, please ventilate immediately. Poisonous gas will emerge if the refrigerant gas meets fire.



Wire size of power cord should be large enough. The damaged power cord and connection wire should be replaced by exclusive cable.

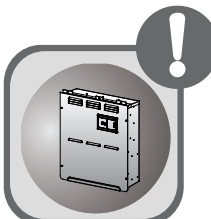

After connecting the power cord, please fix the electric box cover properly in order to avoid accident.

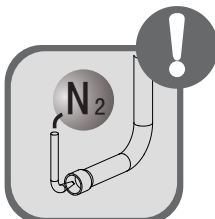

Never fail to comply with the nitrogen charge requirements. Charge nitrogen when welding pipes.

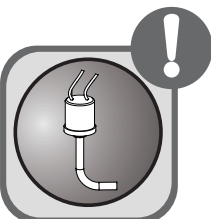

Never short-circuit or cancel the pressure switch to prevent unit damage.



Please firstly connect the wired controller before energization, otherwise wired controller can not be used.



Before using the unit, please check if the piping and wiring are correct to avoid water leakage, refrigerant leakage, electric shock, or fire etc.

# Multi Variable Air Conditioners Duct Type Indoor Unit

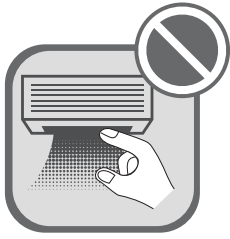

Do not insert fingers or objects into air outlet/inlet grille.



Open the door and window and keep good ventilation in the room to avoid oxygen deficit when the gas/oil supplied heating equipment is used.



Never start up or shut off the air conditioner by means of directly plug or unplug the power cord.

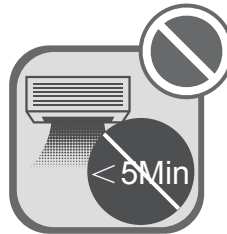

Turn off the unit after it runs at least five minutes; otherwise it will influence oil return of the compressor.



Do not allow children operate this unit.



Do not operate this unit with wet hands.

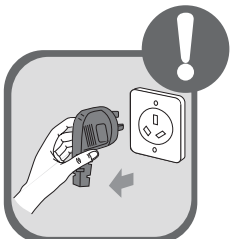

Turn off the unit or cut off the power supply before cleaning the unit, otherwise electric shock or injury may happen.



Never spray or flush water towards unit, otherwise malfunction or electric shock may happen.



Do not expose the unit to the moist or corrosive circumstances.



Electrify the unit 8 hours before operation. Please switch on for 8 hours before operation. Do not cut off the power when 24 hours short-time halting (to protect the compressor).

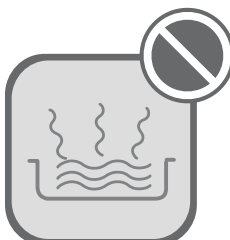

Volatile liquid, such as diluent or gas will damage the unit appearance. Only use soft cloth with a little neutral detergent to clean the outer casing of unit.

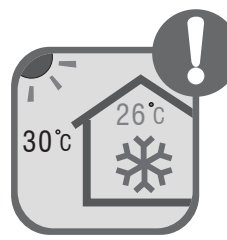

Under cooling mode, please don't set the room temperature too low and keep the temperature difference between indoor and outdoor unit within 5°C.



If anything abnormal happens (such as burning smell), please power off the unit and cut off the main power supply, and then immediately contact AlpicAir appointed service center. If abnormality keeps going, the unit might be damaged and lead to electric shock or fire.



User is not allowed to repair the unit. Fault service may cause electric shock or fire accidents. Please contact AlpicAir appointed service center for help.

Any personal injury or property loss caused by improper installation, improper debug, unnecessary repair or not following the instructions of this manual should not be the responsibility of AlpicAir.

## 2 Product Introduction

### 2.1 Names of Key Components

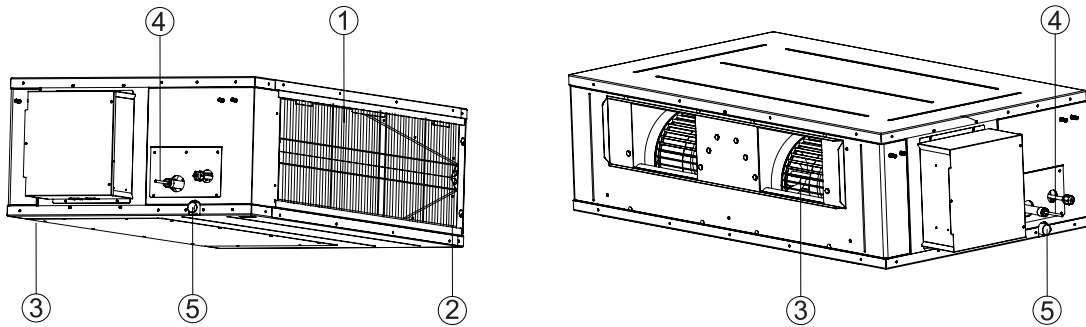

No.	①	②	③	④	⑤
Name	Filter	Air Inlet	Air Outlet	Fittings	Drain Pipe

### 2.2 Rated Working Condition

	Indoor Side Condition		Outdoor Side Condition	
	Dry Bulb Temp °C	Wet Bulb Temp °C	Dry Bulb Temp °C	Wet Bulb Temp °C
Rated Cooling	27	19	35	24
Rated Heating	20	15	7	6

Indoor Unit Working Temperature Range: 16°C~ 32°C.

### 2.3 Unit Functions

Unit Functions	Wired Controller XK46(Standard)	Wired Controller XK49(Optional)	Remote Controller YAD1F(Optional)	Remote Controller YV1L1(Optional)
Operation Mode (Cooling, Heating, Fan, Dehumidifying)	✓	✓	✓	✓
Fan Speed Adjustment	✓	✓	✓	✓
Temperature Adjustment	✓	✓	✓	✓
X-fan Function	✓	✗	✓	✓
Quiet Function	✓	✗	✓	✓
Sleep Function	✓	✗	✓	✓
Save Function	✓	✗	✗	✓
E-heater Function	✓	✗	✓	✓
Memory Function	✓	✓	✗	✗
Absence Function	✓	✗	✗	✓
Timer Function	✓	✗	✓	✓
Low Temp Dehumidify Function	✓	✗	✗	✓
Filter Cleaning Reminding Function	✓	✗	✗	✗
I Feel	✗	✗	✗	✓
Light Function	✓	✗	✓	✓
Swing	✓	✓	✓	✓

**⚠ Notes:**

① √: included, X: not included











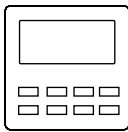
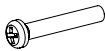

② Please refer to the user manual of Wired Controller or Remote Controller for function details.

## 3 Preparations for Installation

Note: Product graphics are only for reference. Please refer to actual products. Unspecified measure unit is mm.

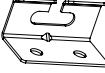
### 3.1 Standard Fittings

Please use the supplied standard fittings listed below as instructed.

No.	Name	Appearance	Q'ty	Usage
1	Wired Controller		1	To control the indoor unit
2	M4X25 Screw (Cross recessed small pan head screw)		2	To fix the wired controller
3	Special Nut		1	To be used for connecting the refrigerant pipe
4	M10 Nut (Nut with Washer M10X8)		4	To be used together with the hanger bolt for installing the unit.
5	M10 Nut (M10X8.4)		8	To be used together with the hanger bolt for installing the unit.
6	M10 Washer (Spring Washer M10X2.6)		4	To be used together with the hanger bolt for installing the unit.
7	M10 Washer (M10Xφ30X2.5)		4	To be used together with the hanger bolt for installing the unit.
8	Insulation		1	To insulate the gas pipe
9	Insulation		1	To insulate the liquid pipe
10	Fastener		8	To fasten the sponge
11	Hanger		4	To fix the indoor unit
12	M8 Nut (M8X6.8)		8	To fix the hook on the cabinet of the unit.
13	M8 Washer (Spring Washer M8X2.1)		8	To fix the hook on the cabinet of the unit.
14	M8 Washer (M8Xφ16X1.5)		8	To fix the hook on the cabinet of the unit.



### 3.2 Location for Installation

- (1) The appliance shall not be installed in the laundry.
- (2) The top holder must be strong enough to support unit's weight.
- (3) Drain pipe can drain water out easily.
- (4) There is no obstacle at inlet or outlet. Please ensure good air circulation.
- (5) In order to make sure the space for maintenance, please install the indoor unit according to the dimension described below.
- (6) Keep the unit away from heating source, inflammable gas or smoke.
- (7) This is a concealed ceiling type unit.
- (8) Indoor unit, outdoor unit, power cord and electric wire should stay at least 1m from the TV set and radio. Otherwise, these electrical appliances may have image interference and noise. (Even if the distance is 1m, when there is strong electric wave, noise may still occur.)

Unit: mm

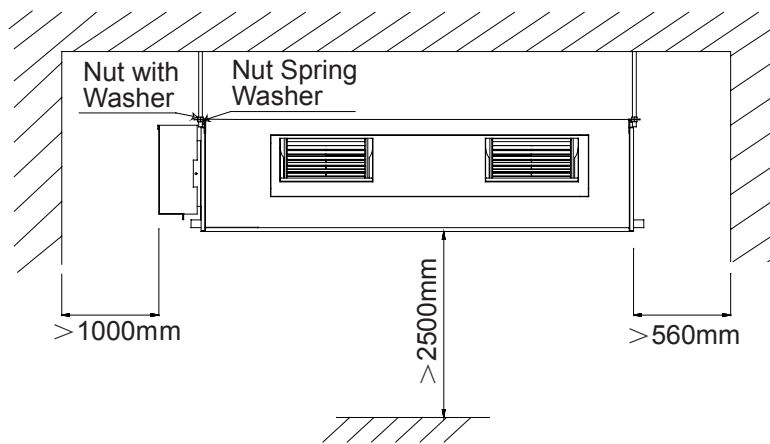

Fig 3.2

#### ⚠ Notes:

- ① Installation of the unit must be in accordance with National Electric Codes and local regulations.
- ② Improper installation will affect unit's performance, so do not install the unit by yourself. Please contact local dealer to arrange professional technicians for the installation.
- ③ Do not connect power until all installation work is finished.

### 3.3 Requirements for Communication Line

#### ⚠ Notes:

If the unit is installed in the place with strong electromagnetic interference, shielded wire must be applied on the communication wire between indoor unit and wired controller. Twisted pair line with shielding function must be applied on the communication wire between indoor unit and indoor unit(outdoor unit).

#### 3.3.1 Select communication line for indoor unit and wired controller

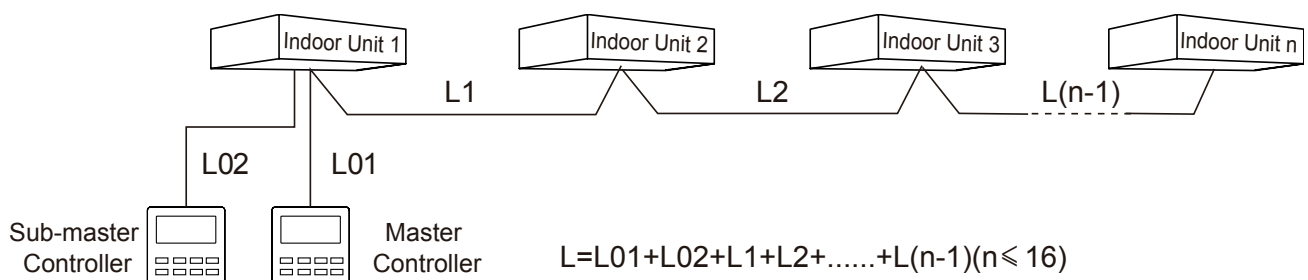

Fig 3.3.1

## Multi Variable Air Conditioners Duct Type Indoor Unit

Wire Type	Total Length of Communication Line L(m)	Wire Gauge (mm <sup>2</sup> )	Wire Standard	Remark
Light/Common PVC Jacket Soft Wire	$L \leq 250$	$2 \times 0.75 \sim 2 \times 1.25$	IEC 60227-5	1. The total length of communication line should not exceed 250m 2. The cord shall be Circular cord (the cores shall be twisted together). 3. If unit is installed in places with intense magnetic field or strong interference, it is necessary to use shielded wire.

### 3.3.2 Select communication line for indoor unit and outdoor unit

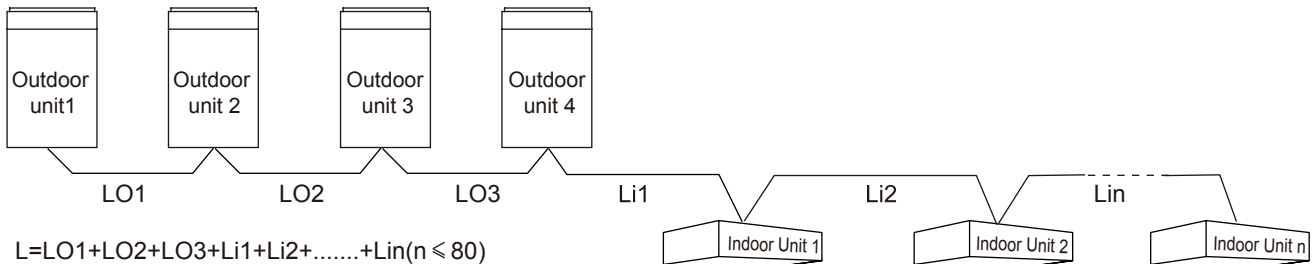

Fig 3.3.2

Wire Type	Total Length of Communication Line L(m)	Wire Gauge (mm <sup>2</sup> )	Wire Standard	Remark
Light/Common PVC Jacket Soft Wire	$L \leq 1000$	$\geq 2 \times 0.75$	IEC 60227-5	1. If the wire diameter is enlarged to $2 \times 1 \text{ mm}^2$ , the total communication line length can reach 1500 m. 2. The cord shall be Circular cord (the cores shall be twisted together). 3. If unit is installed in places with intense magnetic field or strong interference, it is necessary to use shielded wire.

## 3.4 Wiring Requirements

### (1) Power Cord Size and Air Switch Capacity

Model	Power Cord Size	Air Switch capacity (A)	Minimum Sectional Area of Ground Wire	Minimum Sectional Area of Power Cord (mm <sup>2</sup> )
ATMI-224VRDC1A	220~240V-1ph-50Hz 208~230V-1ph-60Hz	10	1.0	1.0
ATMI-280VRDC1A		16	1.5	1.5

#### ⚠ Notes:

- ① Use copper wire only as unit's power cord. Operating temperature should be within its rated value.
- ② If the power cord is more than 15m long, please increase properly the sectional area of power cord to avoid overload, which may cause accident.
- ③ Above selection requirements: Power cord size is based on BV single-core wire (2~4pc) at 40°C ambient temperature when laying across plastic pipe. Air switch is D type and used at 40°C.

If actual installation condition varies, please lower the capacity appropriately according to the specifications of power cord and air switch provided by manufacturer.

- (2) Install cut-off device near the unit. The minimum distance between each stage of cut-off device should be 3mm(The same for both indoor unit and outdoor unit).

## 4 Installation Instructions

### 4.1 Installation of Indoor Unit

#### 4.1.1 Outline Dimension and Installation Spots

Equip with a inspection hatch after lifting the unit. For the convenience of maintenance, the service port should be on one side of the electric box and below unit's lower level.

- (1) Below are the outline dimension applicable to indoor units

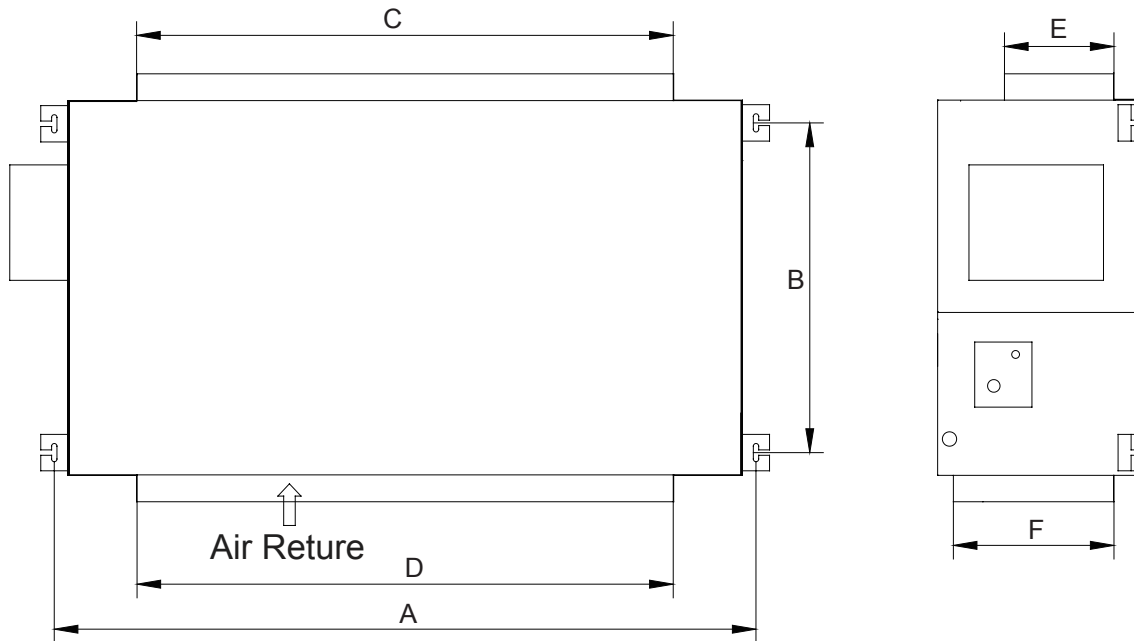

Fig 4.1.1

Below are dimensions of A, B, C, etc. for different models:

Unit: mm

Model	A	B	C	D	E	F
ATMI-224VRDC1A	1353	632	992	1150	192	327
ATMI-280VRDC1A	1563	706	992	1350	192	402

- (2) Drill bolt holes and install bolts

- 1) Stick the reference cardboard on the installation position; drill 4 holes according to the hole site on the cardboard as shown in fig 4.1.2; diameter of drilling hole is according to the diameter of expansion bolt and the depth is 60-70mm, as shown in fig 4.1.3.

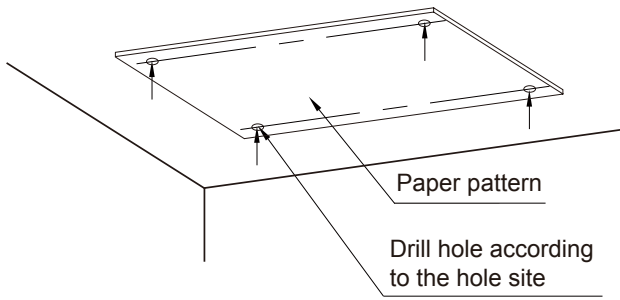

Fig 4.1.2

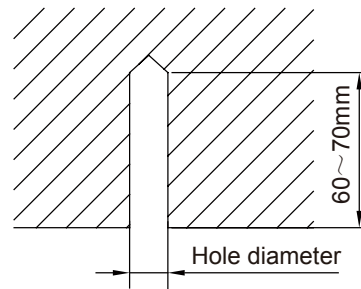

Fig 4.1.3

2) Insert the M10 expansion bolt into the hole and then knock the nail into the bolt, as shown in fig 4.1.4.

⚠ Notes:

The length of bolt depends on the installation height of the unit, bolts are field supplied.

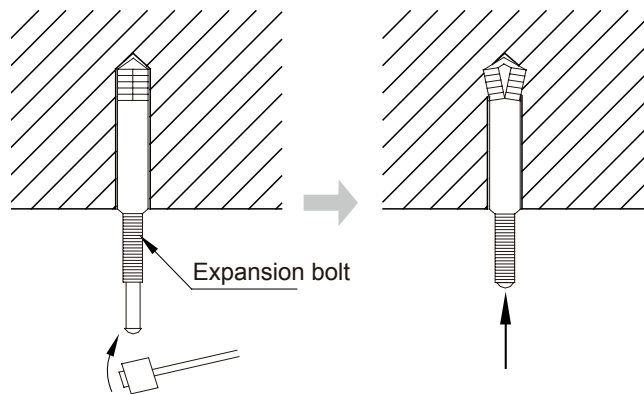

Fig 4.1.4

(3) Install the indoor unit temporarily

Assemble suspension bolt on the expansion bolt, attach the hanger bracket to the suspension bolt. Be sure to fix it securely by using a nut and washer from upper and lower sides of the hanger bracket. The washer fixing plate will prevent the washer from falling.

(4) The usage of paper pattern

Refer to paper pattern of installation for ceiling opening dimension. The center of ceiling opening is indicated on the paper pattern. Fix the paper pattern to the unit with 4 screws and fix the corners of the waterspout at the drainage pipe by screws.

(5) Adjust the unit to the right position.

(6) Check the level of the unit

The indoor unit is equipped with build-in water pump and float switch, verify the levelness of 4 directions by level gauge or vinyl tube (filled with water) respectively.

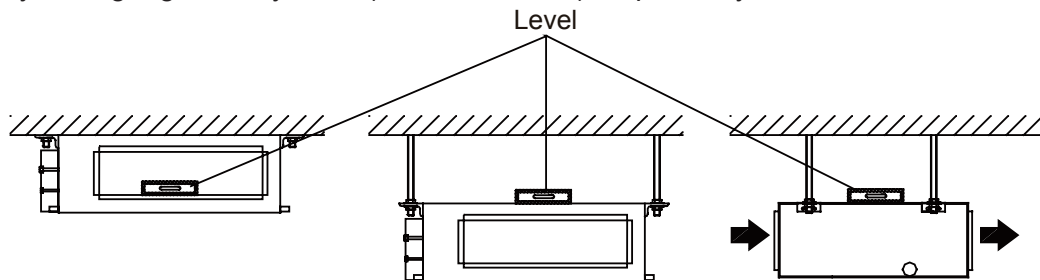

Fig 4.1.5

(7) Remove the washer locating plate and then tighten the nut on it.

(8) Remove the paper pattern.

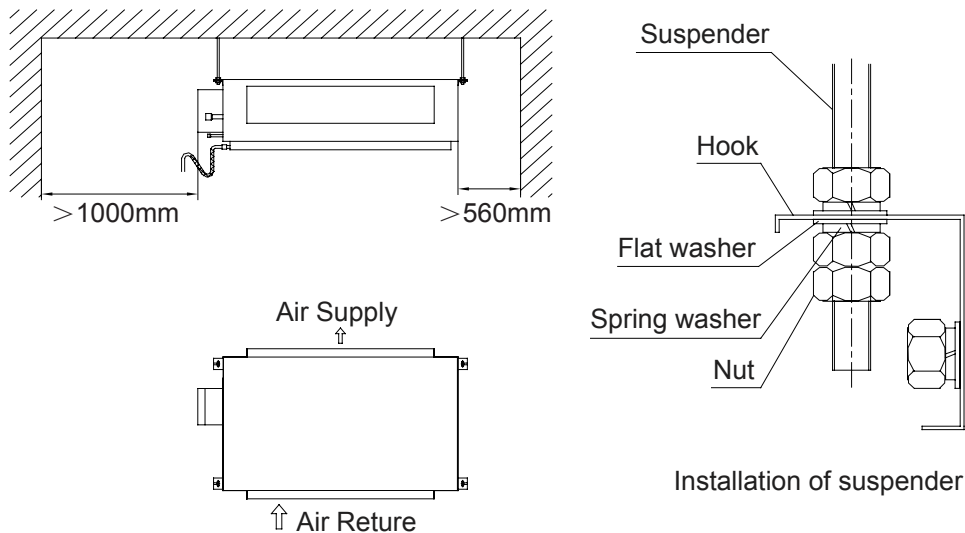

Fig 4.1.6

## 4.2 Refrigerant Pipe Connection

- (1) Aim the flaring port of copper pipe at the center of screwed joint and then tighten the flaring nut with hand as shown in fig 4.2.
- (2) Tighten the flaring nut with torque wrench.

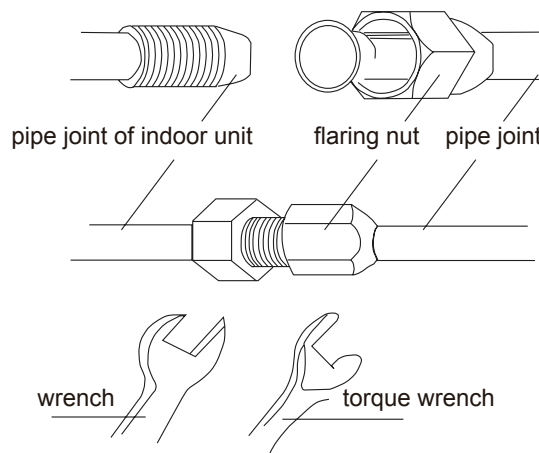

Fig.4.2

- (3) Use pipe bend when bending the pipe and the bending angle should not be too small.
- (4) Wrap the connection pipe and joint with sponge and then tie them firmly with tape.

## 4.3 Drainage Pipe Installation and Drainage System Testing

### 4.3.1 Notice for Installation of Drain Pipe

- (1) The drainage pipe should be short and the gradient downwards should be at least 1%~2% in order to drain condensation water smoothly.
- (2) The diameter of drainage hose should be bigger or equal to the diameter of drainage pipe joint.
- (3) Install drainage pipe according to the following fig and arrange insulation to the drainage pipe. Improper installation may lead to water leakage and damp the furniture and other things in the room.
- (4) You can buy normal hard PVC pipe used as the drainage pipe. During connection, insert the end of PVC pipe into the drainage hole and then tighten it with drainage hole and wire binder. Can't connect the drainage hole and drainage hole with glue.
- (5) When the drainage pipelines are used for several units, the position of pipeline should be

about 100mm lower than the drainage port of each unit. In this case, thicker pipes should be applied.

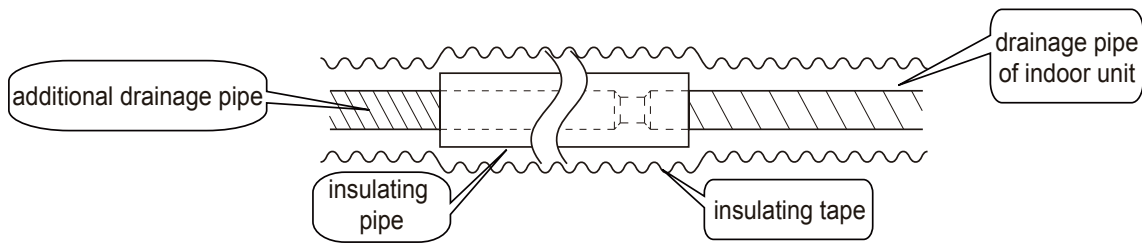

Fig 4.3.1

### 4.3.2 Drainage pipe installation

- 1) Insert the drain hose into the drain hole and tighten it with tapes, as shown in Fig 4.3.2.
- 2) Tighten the pipe clamp, with the distance between screw nut and hose smaller than 4mm.
  - ① metal clamp(accessory)
  - ② drain hose(accessory)
- 3) Use sealing plate to make the pipe clamp and hose insulated, as shown in Fig.4.3.3.
  - ① metal clamp(accessory)
  - ② hermal sponge(accessory)

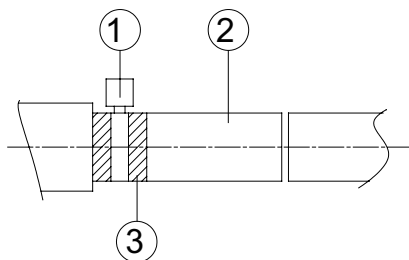

Fig 4.3.2

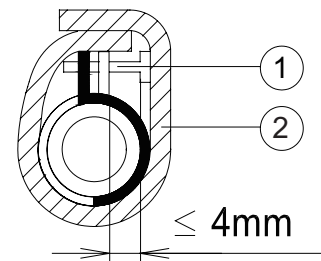
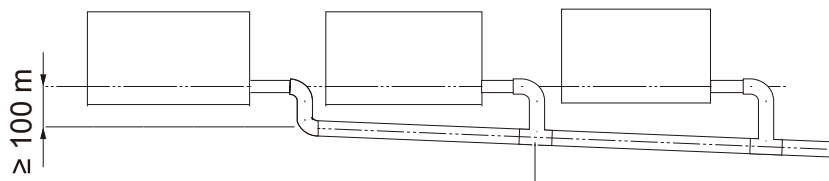

Fig 4.3.3

- 4) When connecting several drain pipes, follow the instruction as indicated in Fig 4.3.4. Choose the drain collecting pipe that matches with unit capacity.



T Joint of Collecting Pipe

Fig 4.3.4

- 5) Install the trap as shown in following Fig 4.3.5.
- 6) Install one trap for each unit.
- 7) Convenience for cleaning trap in the future should be considered when installing it.

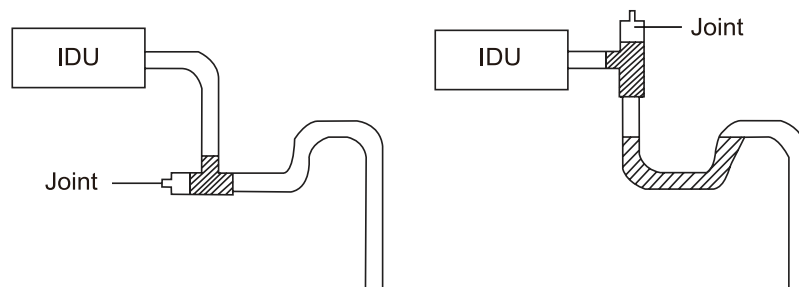

Fig 4.3.5

8) The horizontal pipe can be connected to vertical pipe in the same level; please select the connection way as shown in following fig.

NO1: Connection of drainage pipe joints (Fig4.3.6)

NO2: Connection of downspout elbow (Fig4.3.7)

NO3: Inserting pipe connection (Fig4.3.8)

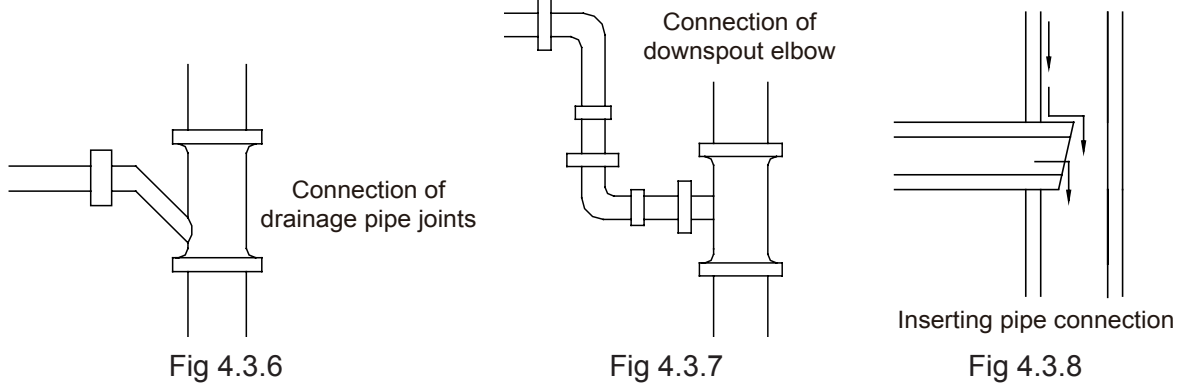

9) Drain pipes should have a downward slope of at least 1%~2%, in order to prevent pipes from sagging, install hanger bracket at intervals of 1000~1500mm.

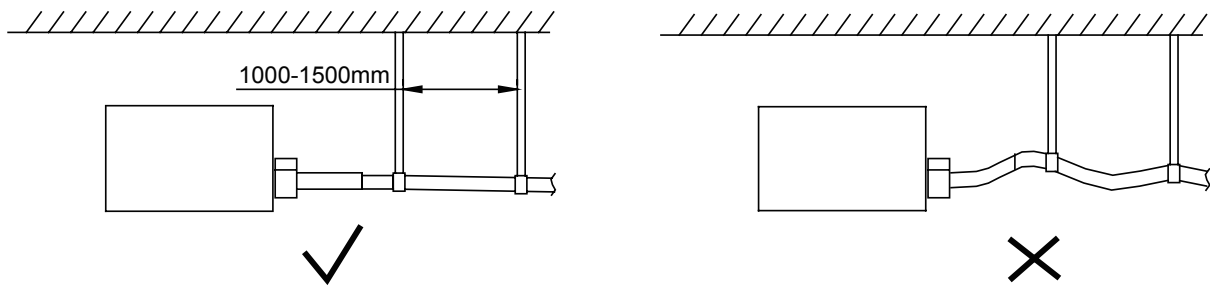

### 4.3.3 Test of Drainage System

- (1) Please test drainage system after electric work is finished. Inject approximately 1L purified water to drain pan from air vent, ensure that not to splash the water over the electrical components (e.g. water pump. etc).
- (2) During the test, please carefully check the drainage joint, make sure no any leakage occur.
- (3) It's strongly recommend to do the drain test before ceiling decoration.

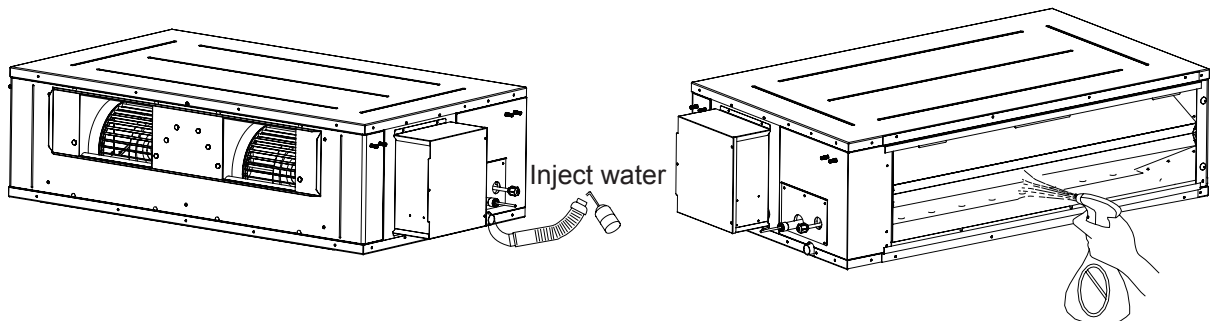

### 4.4 Installation of Air Duct

⚠ Notes:

- ① There should be insulating layer on air-out duct, air-return duct and fresh air duct to avoid heat loss and moisture. Adhere a nail on the air duct and then add thermal sponge with a layer of tin.

Fasten it with a nail cover and then seal the junction with tin tapes; You can also use other materials that have good insulation quality.

② Each air-out duct and air-return duct should be fixed on a pre-made board with iron frame. The junction of air duct should be well-sealed in order to prevent air leakage.

③ The design and construction of air duct should comply with national requirements.

④ The edge of air-return duct is suggested to be more than 150mm away from the wall. Add a filter to the air-return opening.

⑤ Please consider noise-damping and vibration damping for the design and construction of air duct. Besides, noise source must be away from people. For instance, do not have the air-return opening installed on top of the user(offices, rest area, etc.).

#### 4.4.1 Installation of Air-out Duct

##### (1) Installation of the Rectangular Duct

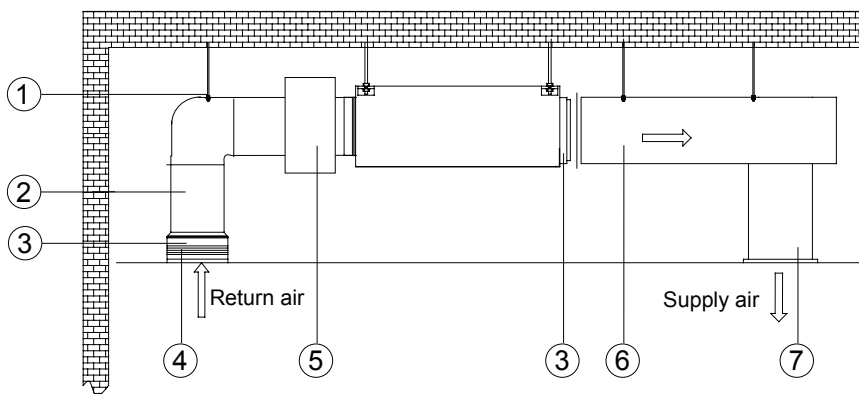

Fig 4.4.1

No.	Name	No.	Name
1	Hanger Rod	5	Static Pressure Box
2	Return Air Duct	6	Main Supply Air Duct
3	Canvas Duct	7	Supply Air Outlet
4	Return Air Inlet		

#### 4.4.2 Shape and Size of Air Outlet and Air-return Opening

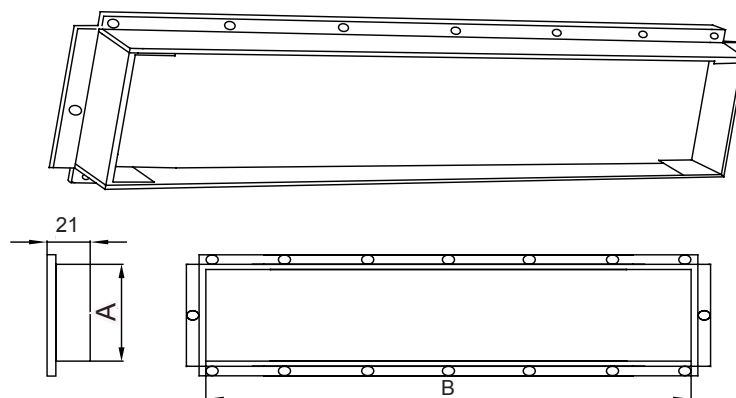

Fig 4.4.2 Air Outlet



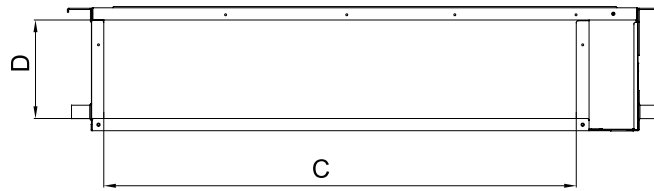

Fig 4.4.3 Air-return Opening

Model	Size of Air Outlet		Size of Air –return Opening	
	A	B	C	D
ATMI-224VRDC1A	192	992	1150	327
ATMI-280VRDC1A	192	992	1350	402

#### 4.5 Installation of Wired Controller

Please refer to User Manual of Wired Controller for the installation details.

Note: When installation is finished, the unit must be tested and debugged before operation. Please refer to Instruction Manual of ODU for auto addressing and debugging details.

#### 4.6 External Static Pressure Settings

Unit parameters can be set in unit On or Off status.

(1) Long press FUNCTION button for 5s and the temperature zone displays “C00”; long press FUNCTION button for another 5s to enter the interface of setting wired controller parameters. “P00” is displayed in temperature zone;

(2) Press “▲” or “▼” button to select parameter code. Press MODE button to enter parameter setting. At that time, parameter value is blinking. Press “▲” or “▼” button to adjust the parameter value and press ENTER/CANCEL button to finish setting.

(3) Press ENTER/CANCEL button to return to last step until exists setting parameters.

The parameter setting list is as following:

Parameter code	Parameter name	Parameter range	Default value	Note
P30	Set static pressure of indoor fan motor	01-09: static pressure level of indoor fan motor	05	There are two kinds of static pressure level: 5 levels: 03, 04, 05, 06, 07 9 levels: 01, 02, 03, 04, 05, 06, 07, 08, 09 Static pressure level range is different for different models; the wired controller will automatically select static pressure level range of indoor fan motor according to the model of indoor unit.

**⚠ Notes:**

① Under parameter setting status, FAN, TIMER, SLEEP and SWING button are invalid. Press ON/OFF button to go back to home page, but not turning on/off the unit.

② Under parameter setting status, the signal from remote controller is invalid. The parameter of External Static Pressure list is as following:

External Static Pressure	static pressure level of indoor fan motor
0.28 inWG(70 Pa)	01
0.36 inWG(90 Pa)	02
0.44 inWG(110 Pa)	03
0.52 inWG(130 Pa)	04
0.60 inWG(150 Pa)	05
0.64 inWG(160 Pa)	06
0.68 inWG(170 Pa)	07

0.72 inWG(180 Pa)	08
0.80 inWG(200 Pa)	09

**⚠ Notes:**

- ① Keep in mind that a shortage of airflow quantity or water leakage will result because the air conditioner will be operated outside the rated range of airflow quantity if the external static pressure is wrongly set.
- ② The Sound Pressure Level will change if the external static pressure is wrongly set.

## 5 Wiring Work

**⚠ Warning!**

Before obtaining access to terminals, all supply circuits must be disconnected.

**⚠ Notes:**

- ① Units must be earthed securely, or it may cause electric shock.
- ② Please carefully read the wiring diagram before carry out the wiring work, incorrect wiring could cause malfunction or even damage the unit.
- ③ The unit should be powered by independent circuit and specific socket.
- ④ The wiring should be in accordance with related regulations in order to ensure the units reliable running.
- ⑤ Install circuit breaker for branch circuit according to related regulations and electrical standards.
- ⑥ Keep cable away from refrigerant pipings, compressor and fan motor.
- ⑦ The communication wires should be separated from power cord and connection wire between indoor unit and outdoor unit.
- ⑧ Adjust the static pressure via wired controller according to site circumstance.

### 5.1 Connection of Wire and Patch Board Terminal

(1) The connection of wire (as shown in fig 5.1.1)

- 1) Strip about 25mm insulation of the wire end by stripping and cutting tool.
- 2) Remove the wiring screws on the terminal board.
- 3) Shape the tail of wire into ring by needle nose plier, and keep the gauge of ring in accordance with screw.
- 4) Use the screwdriver for tightening the terminal.

(2) The connection of stranded wire (as shown in fig 5.1.2)

- 1) Strip about 10mm insulation of the end of stranded wire by stripping and cutting tool.
- 2) Loosen the wiring screws on terminal board.
- 3) Insert the wire into the ring tongue terminal and tighten by crimping tool.
- 4) Use the screwdriver for tightening the terminal.

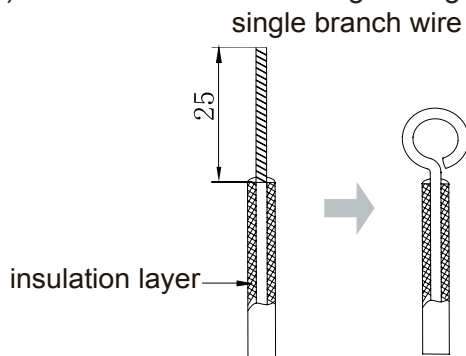

Fig 5.1.1

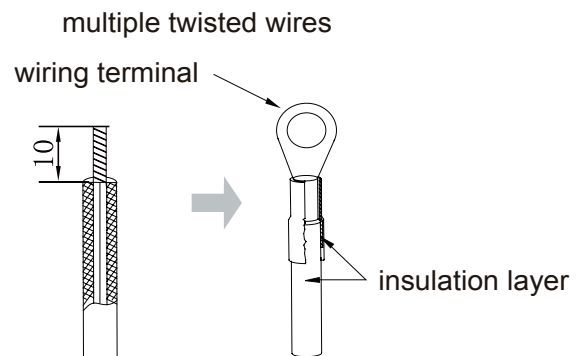

Fig 5.1.2

## 5.2 Power Cord Connection

⚠ Notes:

All indoor units must be unified of power supply so that they can be powered ON/OFF at the same time.

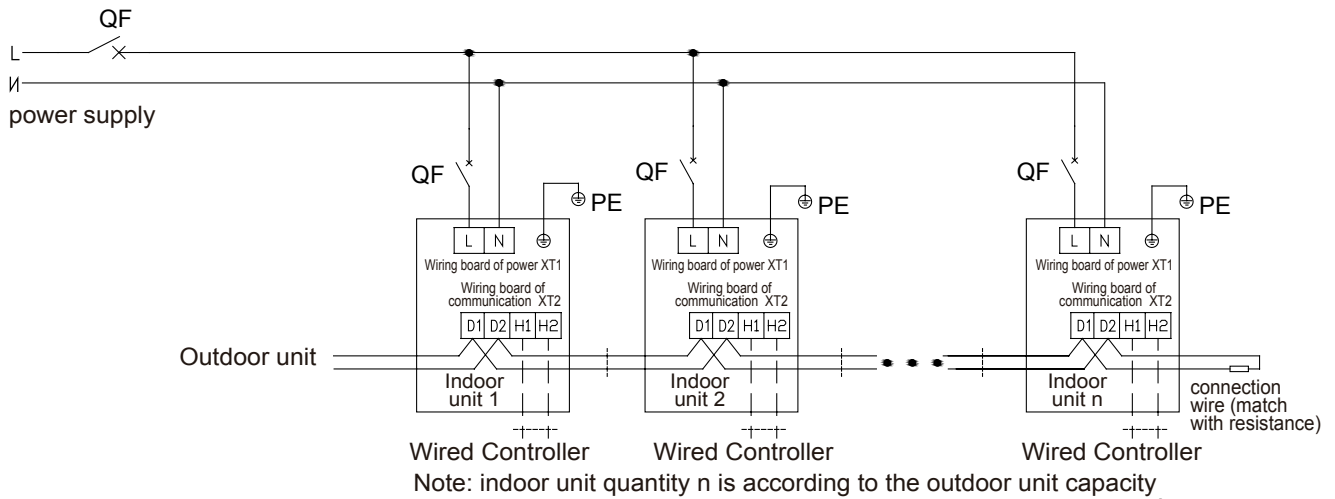

Fig 5.2

For units with single-phase power supply.

- (1) Detach the electric box lid.
- (2) Let the power cord pass through the wiring through-holes.
- (3) Connect the power cord to terminal "L, N, ⊕".
- (4) Fix the power card with wiring clamp.

## 5.3 Connection of Communication Wire between Indoor Unit and Outdoor Unit(or indoor unit)

- (1) Detach the electric box lid.
- (2) Let the Communication cable pass through the wiring through-holes.
- (3) Connect the communication wire to terminal D1 and D2 of indoor 4-bit wiring board, as shown in fig5.3.1.

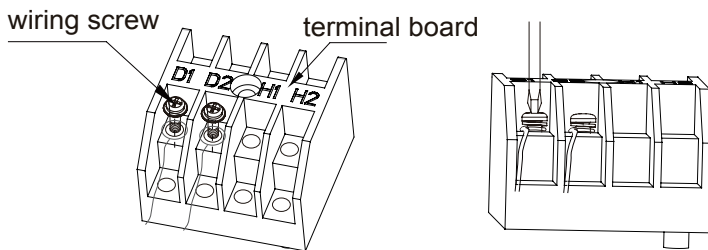

Fig 5.3.1

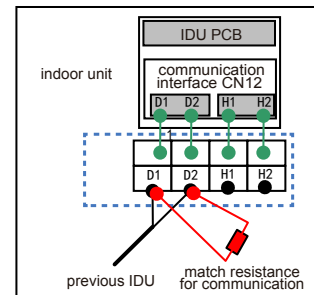

Fig 5.3.2

- (4) Fix the communication cable with clamp of electric box.
- (5) For more reliable communication, make sure connect the terminal resistor to the most downstream IDU of the communication bus (terminal D1 and D2), as shown in fig 5.3.2, terminal resistor is provided with each ODU.

## 5.4 Connect Communication Wire of Wired Controller

- (1) Open electric box cover of indoor unit.
- (2) Let the communication wire go through the rubber ring.
- (3) Connect the communication wire to terminal H1 and H2 of indoor 4-bit wiring board.
- (4) Fix the communication wire with wire clip on the electric box.

(5) Wiring instructions of remote receiving light board and wired controller:

1) Fig 5.4.1 shows the installation of wired controller.

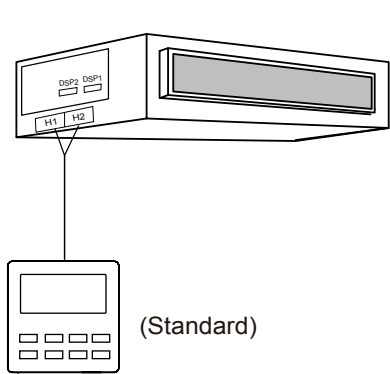

Fig 5.4.1

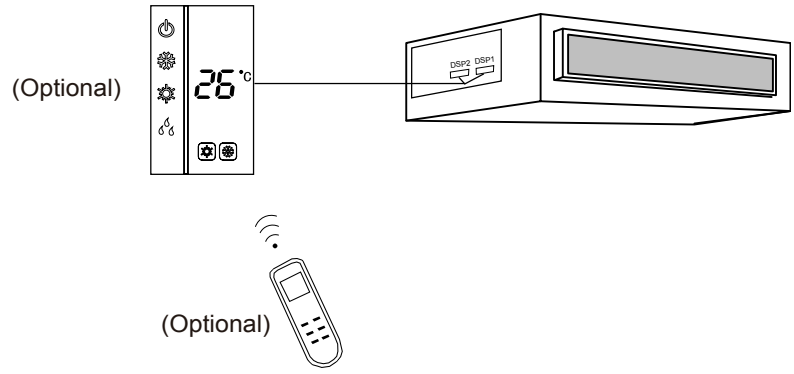

Fig 5.4.2

2) Fig 5.4.2 shows the installation of remote controller.

3) Wired controller and receiving light board can be installed at the same time. When operating through a remote controller, both wired controller and the receiving light board can receive the signals, as shown in Fig 5.4.3.

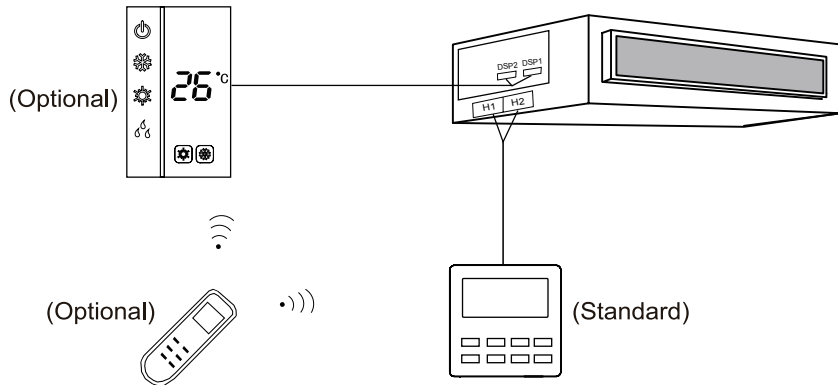

Fig 5.4.3

## 5.5 Illuminate for Connection of Wired Controller and Indoor Units Network

- (1) Communication wire of indoor unit and outdoor unit (or indoor unit) is connected to D1,D2.
- (2) Wired controller is connected to H1,H2.
- (3) One indoor unit can connect two wired controllers that must be set as master one and slave one.
- (4) One wired controller can control 16 indoor unitS in maximum at the same time. (as shown in fig5.5)

⚠ Notes:

- ① The type of indoor units must be the same if they are controlled by the same wired controller.
- ② When the indoor unit is controlled by two wired controllers, the addresses of the two wired controllers should be different through address setting. Address 1 is for main controller; Address 2 is for slave controller. Detailed setting please refer to the instruction manual of wired controller.

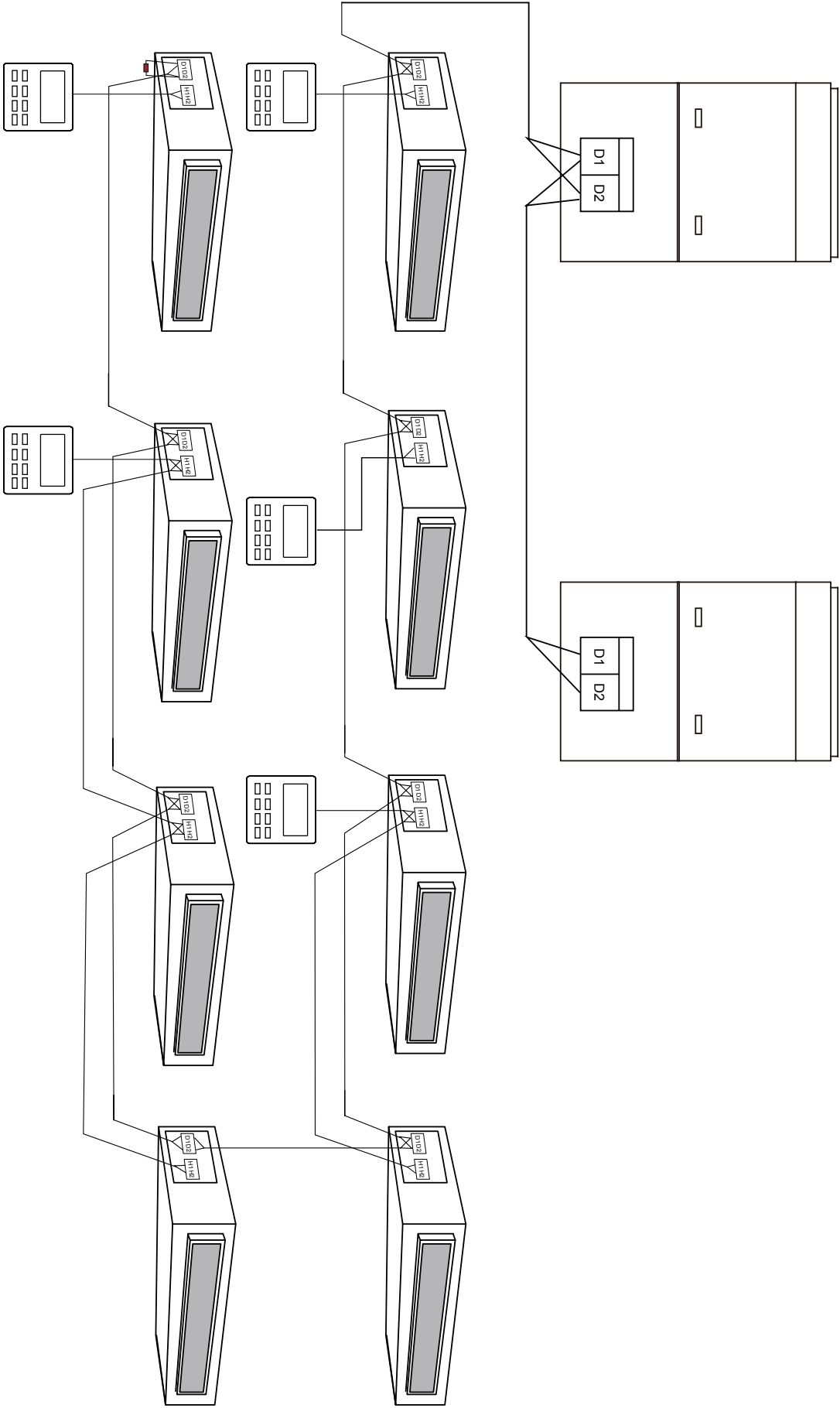

Fig 5.5

## 6 Routine Maintenance

 Warning:

- ① Do not turn off the unit and cut off the main power supply when cleaning the air conditioner to avoid electric shock or injury.
- ② Stand at solid table when cleaning the unit.
- ③ Do not clean the unit with hot water whose temperature is higher than 45°C to prevent fade or deformation.
- ④ Do not dry the filters by fire, or it may catch fire or become deformed.
- ⑤ Clean the filter with a wet cloth dipped in neutral detergent.
- ⑥ Please contact after-sales service staff if there is abnormal situation.

### 6.1 Cleaning of Filter

- (1) Remove the filters from inlet of IDU. Use a vacuum cleaner to remove dust. If the filters are dirty, wash them with warm water and mild detergent, and dry the filters in the shade.
- (2) If the unit used in the environment with much dust, please clean it regularly. (usually once every two weeks).

### 6.2 Maintenance before the Seasonal Use

- (1) Check if the air inlet and air outlet of indoor and outdoor unit are blocked.
- (2) Check if securely grounded.
- (3) Check if all the power cord and communication cable are securely connected.
- (4) Check if any error code displayed after energized.

### 6.3 Maintenance after the Seasonal Use

- (1) Set the unit in fan mode for half a day in a sunny day to dry the inner part of unit;
- (2) When the unit won't be used for a long time, please cut off power supply for energy saving; the characters on the wired controller screen will disappear after cutting off the power supply.

## 7 Table of Error Codes for Indoor Unit

Error Code	Content	Error Code	Content	Error Code	Content
L0	Indoor Unit Error	LA	Indoor Units Incompatibility Error	d8	Water Temperature Sensor Error
L1	Indoor Fan Protection	LH	Low Air Quantity Warning	d9	Jumper Cap Error
L2	E-heater Protection	LC	Outdoor-Indoor Incompatibility Error	dA	Indoor Unit Hardware Address Error
L3	Water Full Protection	d1	Indoor Unit PC-Board Error	dH	Wired Controller PC-Board Error
L4	Wired Controller Power Supply Error	d3	Ambient Temperature Sensor Error	dC	Capacity DIP Switch Setting Error.
L5	Anti-Frosting Protection	d4	Inlet Pipe Temperature Sensor Error	dL	Outlet Air Temperature Sensor Error
L7	No Master Indoor Unit Error	d6	Outlet Pipe Temperature Sensor Error	dE	Indoor Unit CO <sub>2</sub> Sensor Error
L8	Power Insufficiency Protection	d7	Humidity Sensor Error	db	Special Code: Field Debugging Code
L9	Quantity Of Group Control Indoor Units Setting Error				

## 8 Troubleshooting

The air conditioner is not expected to be serviced by users. Incorrect repair may cause electric shock or fire, so please contact an authorized service center for professional service. The following checks prior to contact may save your time and money.

Phenomenon	Troubleshooting
The unit can't start	<ul style="list-style-type: none"> <li>① Power supply is not connected.</li> <li>② Circuit breaker tripping caused by leakage of electricity.</li> <li>③ Input voltage is too low.</li> <li>④ Defect of main PC-board.</li> </ul>
The unit stops after running for a while	<ul style="list-style-type: none"> <li>① The inlet or outlet of ODU or IDU are blocked by obstacle.</li> </ul>
Poor cooling effect	<ul style="list-style-type: none"> <li>① The filter is dirty.</li> <li>② Too heavy heat load of room(e.g. too many people)</li> <li>③ Door or windows is open.</li> <li>④ Inlet and outlet of IDU are blocked.</li> <li>⑤ Setting temperature is too high.</li> <li>⑥ Refrigerant is insufficient (e.g. refrigerant leakage)</li> </ul>
Poor heating effect	<ul style="list-style-type: none"> <li>① The filter is dirty.</li> <li>② Door or window is open.</li> <li>③ Setting temperature is too low.</li> <li>④ Refrigerant is insufficient (e.g. refrigerant leakage)</li> </ul>
Indoor fan doesn't start up during heating	<ul style="list-style-type: none"> <li>① At starting, the IDU fan could not operate till the heat exchange become hot, for preventing delivering the cool air.</li> <li>② At defrosting, the IDU fan stopped due to system switch to cooling mode. for preventing delivering the cool air, and resume operating after defrosting.</li> </ul>

### Notes:

If air conditioner still fails to work normally after checking and handling as described above, please stop using it immediately and contact local service center for assistance.



---

[WWW.ALPICAIR.COM](http://WWW.ALPICAIR.COM)