



Owner's Manual

Original Instructions

Commercial Air Conditioners

Multi Variable Air Conditioners Ducted Type Indoor Unit

Model:

ATMI-160VRDC1A

Thank you for choosing commercial air conditioners. Please read this Owner's Manual carefully before operation and retain it for future reference.

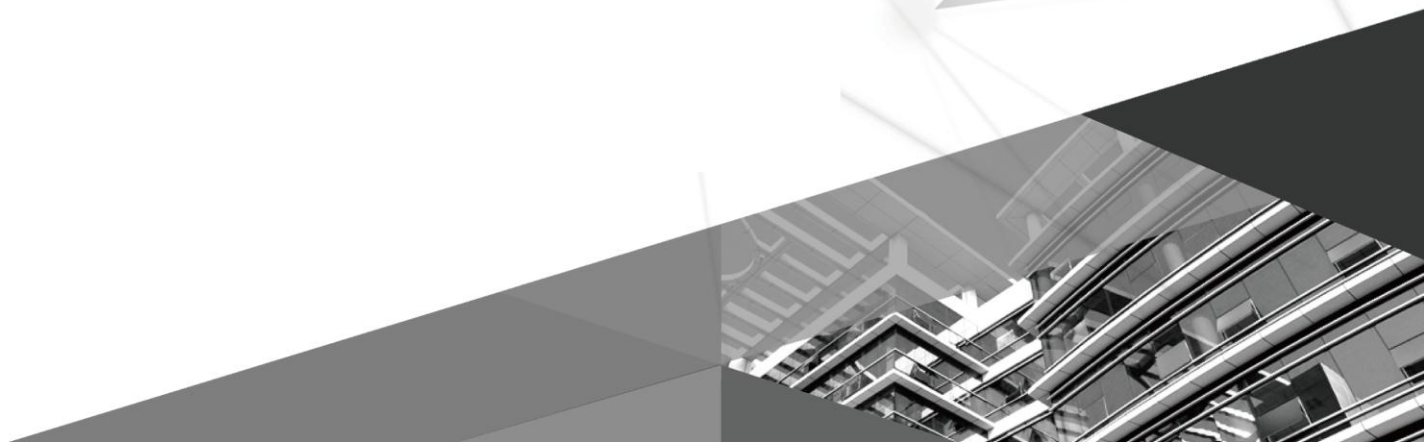

To Users

Thank you for selecting ALPICAIR's product. Please read this instruction manual carefully before installing and using the product, so as to master and correctly use the product. In order to guide you to correctly install and use our product and achieve expected operating effect, we hereby instruct as below:

- (1) This appliance is not intended for use by persons (including children) with reduced physical, sensory or mental capabilities, or lack of experience and knowledge, unless they have been given supervision or instruction concerning use of the appliance by a person responsible for their safety. Children should be supervised to ensure that they do not play with the appliance.
- (2) In order to ensure reliability of product, the product may consume some power under stand-by status for maintaining normal communication of system and preheating refrigerant and lubricant. If the product is not to be used for long, cut off the power supply; please energize and preheat the unit in advance before reusing it.
- (3) Please properly select the model according to actual using environment, otherwise it may impact the using convenience.
- (4) This product has gone through strict inspection and operational test before leaving the factory. In order to avoid damage due to improper disassembly and inspection, which may impact the normal operation of unit, please do not disassemble the unit by yourself. You can contact with the special maintenance center of our company if necessary.
- (5) For personal injury or property loss and damage caused by improper operation such as improper installation and debugging, unnecessary maintenance, violation of related national laws and rules and industrial standard, and violation of this instruction manual, etc., we will bear no liability.
- (6) When the product is faulted and cannot be operated, please contact with our maintenance center as soon as possible by providing the following information.
 - 1) Contents of nameplate of product (model, cooling/heating capacity, product No., ex-factory date).
 - 2) Malfunction status (specify the situations before and after the error occurs).
- (7) All the illustrations and information in the instruction manual are only for reference. In order to make the product better, we will continuously conduct improvement and innovation. We have the right to make necessary revision to the product from time to time due to the reason of sales or production, and reserve the right to revise the contents without further notice.
- (8) The final right to interpret for this instruction manual belongs to AlpicAir.

User Notice

- This appliance can be used by children aged from 8 years and above and persons with reduced physical, sensory or mental capabilities or lack of experience and knowledge if they have been given supervision or instruction concerning use of the appliance in a safe way and understand the hazards involved. Children shall not play with the appliance. Cleaning and user maintenance shall not be made by children without supervision.

- **DISPOSAL:**



This marking indicates that this product should not be disposed with other household wastes. To prevent possible harm to the environment or human health from uncontrolled waste disposal, recycle it responsibly to promote the sustainable reuse of material resources. To return your used device, please use the return and collection systems or contact the retailer where the product was purchased. They can take this product for environmental safe recycling.

- If the supply cord is damaged, it must be replaced by the manufacturer, its service agent or similarly qualified persons in order to avoid a hazard.

Contents

1 Safety Precautions	1
2 Product Introduction	3
2.1 Names of Key Components	3
2.2 Rated Working Condition	3
3 Preparations for Installation	4
3.1 Standard Fittings	4
3.2 Location for Installation	5
3.3 Requirements for Communication Line	6
3.4 Wiring Requirements	7
4 Installation Instructions	7
4.1 Installation of Indoor Unit	7
4.2 Refrigerant Pipe Connection	10
4.3 Drainage Pipe Installation and Drainage System Testing	10
4.4 Installation of Air Duct	14
4.5 Installation of Wired Controller	16
5 Wiring Work	16
5.1 Connection of Wire and Patch Board Terminal	17
5.2 Power Cord Connection	17
5.3 Connection of Communication Wire between Indoor Unit and Outdoor Unit (or indoor unit)	18
5.4 Connect Communication Wire of Wired Controller	18
5.5 Illuminate for Connection of Wired Controller and Indoor Units Network	19
6 Routine Maintenance	21
6.1 Cleaning of Filter	21
6.2 Maintenance before the Seasonal Use	21
6.3 Maintenance after the Seasonal Use	21
7 Table of Error Codes for Indoor Unit	22
8 Troubleshooting	22

1 Safety Precautions

 Warning: If not abide strictly, it may cause severe damage to the unit or the people.









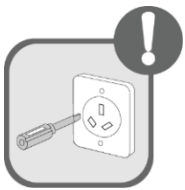

 Note: If not abide strictly, it may cause slight or medium damage to the unit or the people.

 This sign indicates that the operation must be prohibited. Improper operation may cause severe damage or death to people.



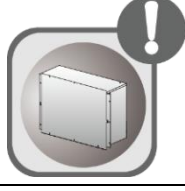
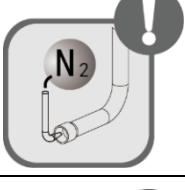









 This sign indicates that the items must be observed. Improper operation may cause damage to people or property.

 **WARNING!**

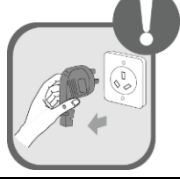
This product can't be installed at corrosive, inflammable or explosive environment or the place with special requirements, such as kitchen. Otherwise, it will affect the normal operation or shorten the service life of the unit, or even cause fire hazard or serious injury. As for above special places, please adopt special air conditioner with anti-corrosive or anti-explosion function .

	<p>Please install the unit according to instructions in this manual. Read this manual carefully before starting up or checking the machine.</p>		<p>Installation should be performed by dealer or qualified technicians. Do not install the product by yourself. Improper installation may result in water leakage, electric shock or fire hazard.</p>
	<p>Make sure the local power supply is in accordance with units before installation, and check the power supply carefully.</p>		<p>This air conditioner must be properly grounded through the receptacle to avoid electric shock. The grounding wire shouldn't be connected with gas pipe, water pipe, lightning arrester or telephone line.</p>
	<p>Please use specialized accessories or parts to carry out installation, or water leakage, electric shock, fire hazard may resulted.</p>		<p>R410A refrigerant can produce poisonous gas once it meets fire, so please ventilate the room immediately if refrigerant leaks out during installation.</p>
	<p>Diameter of power cord must be large enough. Damaged power cord and connecting wire must be replaced by specialized electric cable.</p>		<p>After the power cord is Connected, please install the cover of electric box to avoid danger.</p>
	<p>Nitrogen must be charged according to technical requirements.</p>		<p>Short circuit is forbidden. Do not cancel the pressure switch in case the unit may be damaged.</p>
	<p>For units with wired controller, do not connect power supply until the wired controller is well installed. Otherwise, the wired controller cannot be used.</p>		<p>When the installation is finished, please check and make sure the drain pipe, pipeline and electric wire are all well connected in order to avoid water leakage, refrigerant leakage, electric</p>

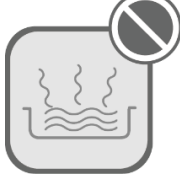
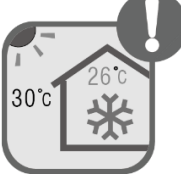
Multi Variable Air Conditioners Ducted Type Indoor Unit

			shock or fire hazard.
	Do not extend fingers or objects into air outlet or air return grille.		If you use gas heater or petroleum heater in the same room, please open the door or window to maintain good air circulation in case the room may lack of oxygen.
	Never start or stop the air conditioner by inserting or removing the power cord.		Do not turn off the air conditioner until it runs for at least 5 minutes. Otherwise, oil-return of the compressor will be affected.
	Children are not allowed to operate the air conditioner.		Do not operate the air conditioner with wet hands.
	Please turn the unit off and unplug your air conditioner before cleaning. Otherwise, it may cause electric shock or personal injury.		Do not spray water on the air conditioner or it will cause malfunction or electric shock.
	Do not expose the air conditioner directly to water or place it in a damp or corrosive environment.		Connect power supply 8 hours before operation. Do not disconnect power if you want to stop the unit in a short period of time, e.g. in one night. (This is for protecting the compressor.)
	Volatile liquid like thinner or gasoline will damage the appearance of air conditioner. (Please use soft dry cloth and wet cloth with mild detergent to clean the outer case of air conditioner.)		During Cooling mode, indoor temperature should not be set too low. Keep the difference between indoor temp and outdoor temp within 5°C.
	If abnormal condition occurs (e.g. unpleasant smell), please turn off the unit at once and disconnect power supply. Then contact ALPICAIR service center. If the air conditioner continues to operate despite of abnormal condition, the unit may be damaged and it may cause electric shock or fire hazard.)		Do not repair the air conditioner by yourself. Improper repair will cause electric shock or fire hazard. Please contact ALPICAIR service center and have it repaired by professional technicians.

2 Product Introduction

2.1 Names of Key Components

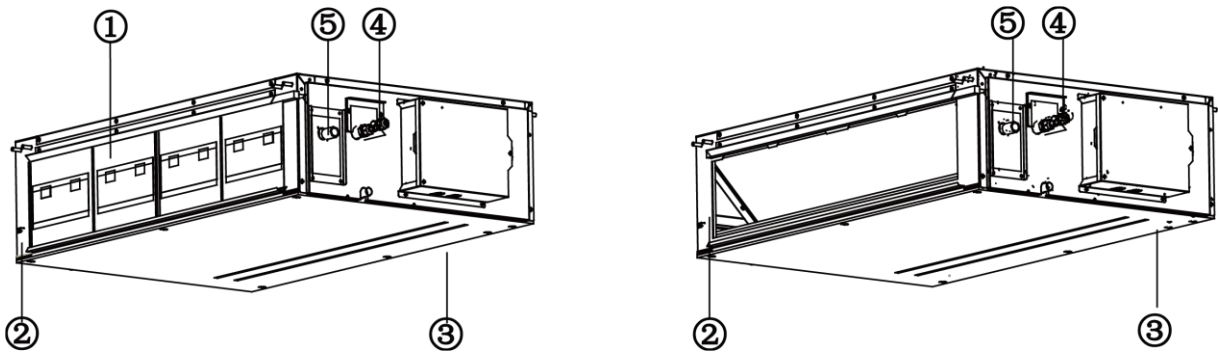

Fig 2.1

No.	①	②	③	④	⑤
Name	Filter	Air Inlet	Air Outlet	Fittings	Drain Pipe

2.2 Rated Working Condition











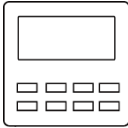
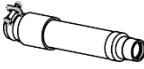

	Indoor Side Condition		Outdoor Side Condition	
	Dry Bulb Temp(°C)	Wet Bulb Temp(°C)	Dry Bulb Temp(°C)	Wet Bulb Temp(°C)
Rated Cooling	27	19	35	24
Rated Heating	20	15	7	6

3 Preparations for Installation

Note: Product graphics are only for reference. Please refer to actual products. Unspecified measure unit is mm.

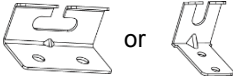
3.1 Standard Fittings

Please use the supplied standard fittings listed below as instructed.

No.	Name	Appearance	Q'ty	Usage
1	Wired Controller		1	To control the indoor unit
2	Drain Hose Assembly		1	To connect with the hard PVC drain pipe
3	Special Nut		1	To be used for connecting the refrigerant pipe
4	M10X8 Nut with Washer		4	To be used together with the hanger bolt for installing the unit.
5	M10 Nut (M10X8.4 Nut)		4	To be used together with the hanger bolt for installing the unit.
6	M10 Washer (Spring Washer M10X2.6)		4	To be used together with the hanger bolt for installing the unit.
7	Insulation		1	To insulate the gas pipe
8	Insulation		1	To insulate the liquid pipe
9	Sponge		2	To insulate the drain pipe
10	Fastener		8	To fasten the sponge
11	Hanger	 or 	4	To fix the indoor unit
12	Nut with Washer		8	To fix the hook on the cabinet of the unit.
13	paper pattern for installation		1	Locate the drill hole on ceiling

3.2 Location for Installation

- (1) The appliance shall not be installed in the laundry.
- (2) The top holder must be strong enough to support unit's weight.
- (3) Drain pipe can drain water out easily.
- (4) There is no obstacle at inlet or outlet. Please ensure good air circulation.
- (5) In order to make sure the space for maintenance, please install the indoor unit according to the dimension described below.
- (6) Keep the unit away from heating source, inflammable gas or smoke.
- (7) This is a concealed ceiling type unit.
- (8) Indoor unit, outdoor unit, power cord and electric wire should stay at least 1m from the TV set and radio. Otherwise, these electrical appliances may have image interference and noise. (Even if the distance is 1m, when there is strong electric wave, noise may still occur.)

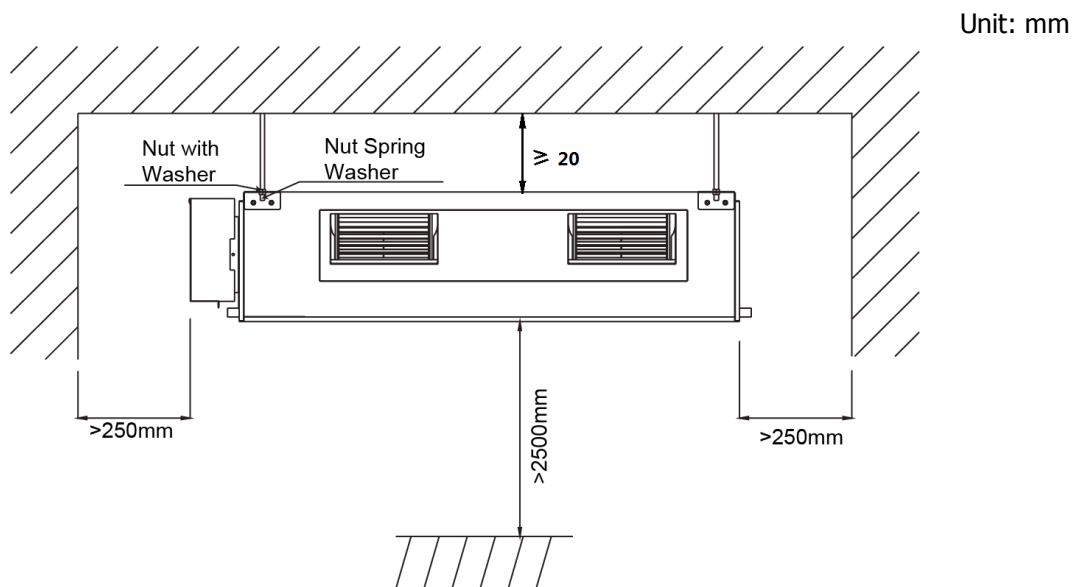

Fig 3.2

! NOTES!

- (1) Installation of the unit must be in accordance with National Electric Codes and local regulations.
- (2) Improper installation will affect unit's performance, so do not install the unit by yourself. Please contact local dealer to arrange professional technicians for the installation.
- (3) Do not connect power until all installation work is finished.
- (4) If the supply cord is damaged, it must be replaced by the manufacturer or its service agent or a similarly qualified person in order to avoid a hazard.

3.3 Requirements for Communication Line



If air conditioner used under strong electronic-magnetic interference circumstance, STP (shielded twisted pair) communication cable must be adopted.

3.3.1 Select Communication Line for Indoor Unit and Wired Controller

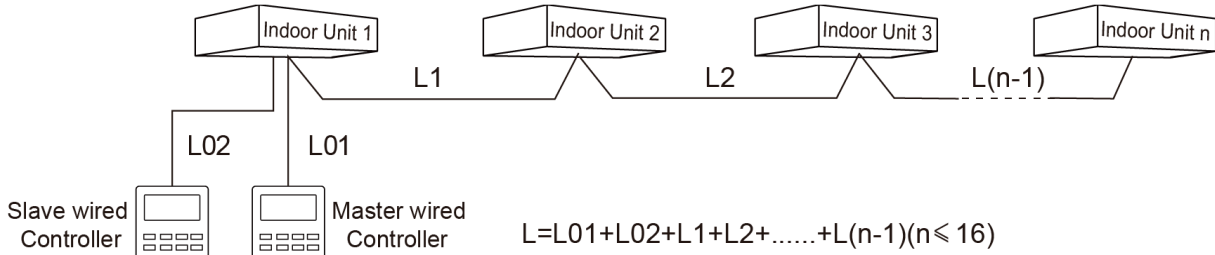

Fig 3.3.1

Material type	Total length of communication line between indoor unit and wired controller L(m)	Wire size (mm ²)	Material Standard	Remarks
Light/Ordinary polyvinyl chloride sheathed cord. (60227 IEC 52 /60227 IEC 53)	$L \leq 250m$	$2 \times 0.75 \sim 2 \times 1.25$	IEC 60227-5	1. Total length of communication line can't exceed 250m 2. The cord shall be Circular cord (the cores shall be twisted together). 3. If unit is installed in places with intense magnetic field or strong interference, it is necessary to use shielded wire.

3.3.2 Select Communication Line for Indoor Unit and Outdoor Unit

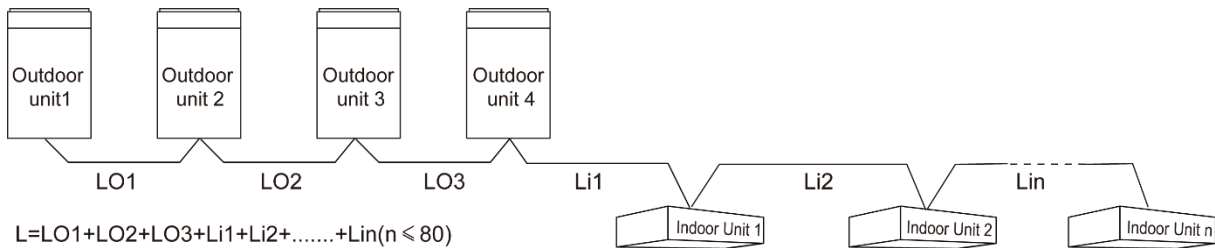

Fig 3.3.2

Material Type	Total Length L (m) of Communication Cable between Indoor Unit and Indoor (Outdoor) Unit	Wire size (mm ²)	Material Standard	Remarks
Light/Ordinary polyvinyl chloride sheathed cord. (60227 IEC 52 /60227 IEC 53)	$L \leq 1000m$	$\geq 2 \times 0.75$	IEC 60227-5	1. If the wire diameter is enlarged to $2 \times 1 \text{ mm}^2$, the total communication line length can reach 1500 m 2. The cord shall be Circular cord (the cores shall be twisted together). 3. If unit is installed in places with intense magnetic field or strong interference, it is necessary to use shielded wire.

3.4 Wiring Requirements

(1) Power Cord Size and Air Switch Capacity

Model	Power Cord Size	Air Switch capacity (A)	Minimum Sectional Area of Ground Wire (mm ²)	Minimum Sectional Area of Power Cord (mm ²)
ATMI-160VRDC1A	220~240V-1ph-50Hz 208~230V-1ph-60Hz	6	1.0	1.0



NOTES!

- ① Use copper wire only as unit's power cord. Operating temperature should be within its rated value.
 - ② If the power cord is more than 15m long, please increase properly the sectional area of power cord to avoid overload, which may cause accident.
 - ③ Above selection requirements: Power cord size is based on BV single-core wire (2~4pc) at 40°C ambient temperature when laying across plastic pipe. Air switch is D type and used at 40°C. If actual installation condition varies, please lower the capacity appropriately according to the specifications of power cord and air switch provided by manufacturer.
 - ④ If the supply cord is damaged, it must be replaced by the manufacturer or its service agent or a similarly qualified person in order to avoid a hazard.
- (2) Install cut-off device near the unit. The minimum distance between each stage of cut-off device should be 3mm (The same for both indoor unit and outdoor unit).

4 Installation Instructions

4.1 Installation of Indoor Unit

4.1.1 Outline Dimension and Installation Spots

Equip with an inspection hatch after lifting the unit. For the convenience of maintenance, the service port should be on one side of the electric box and below unit's lower level.

- (1) Below are the outline dimension applicable to indoor units

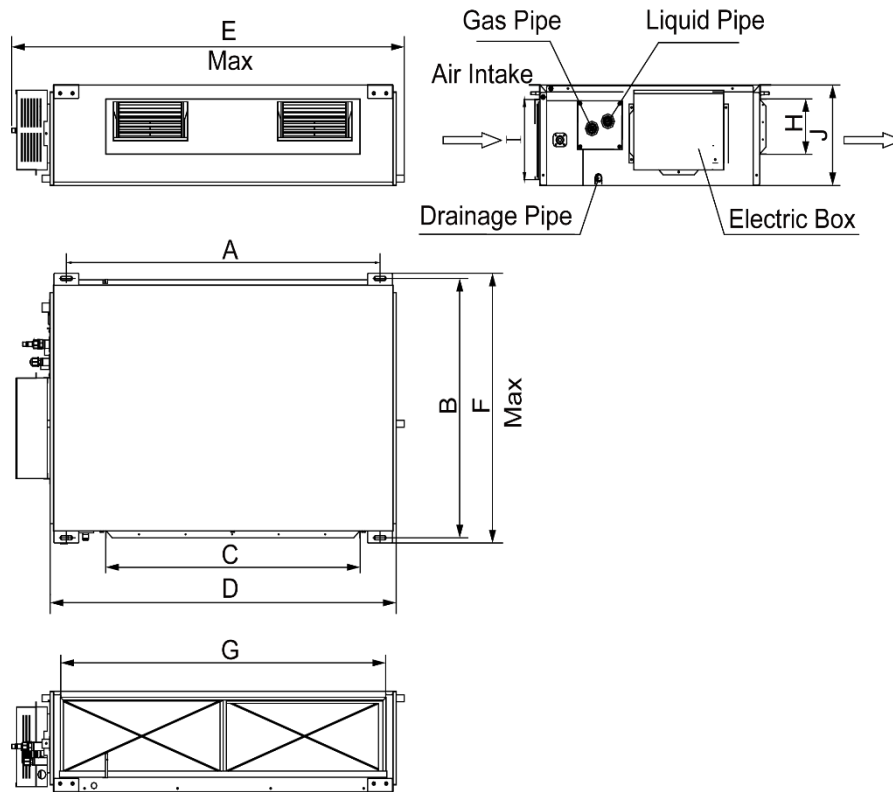

Fig 4.1.1

Below are dimensions of A, B, C, etc. for different models:

Unit: mm

Model	A	B	C	D	E	F	G	H	I	J
ATMI-160VRDC1A	1177	646	852	1150	1340	750	953	190	316	350

4.1.2 Suspend the indoor unit

(1) Drill bolt holes and install bolts

- 1) Stick the reference cardboard on the installation position; drill 4 holes according to the hole site on the cardboard as shown in fig 4.1.3; diameter of drilling hole is according to the diameter of expansion bolt and the depth is 60-70mm, as shown in fig 4.1.4.

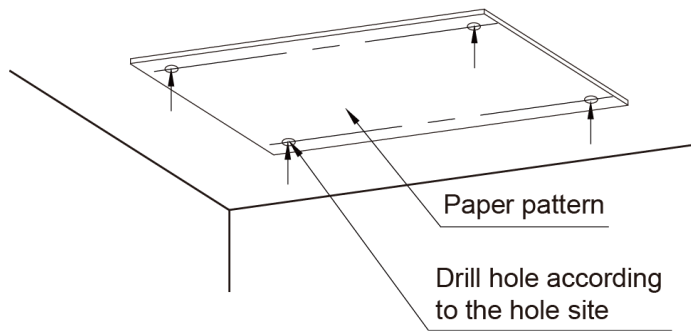

Fig 4.1.3

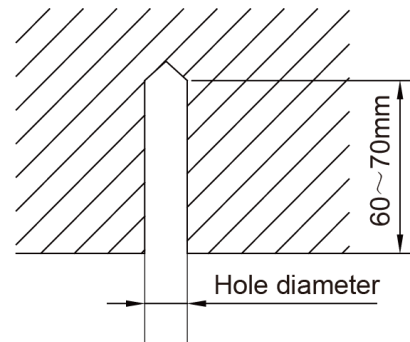

Fig 4.1.4

2) Insert the M10 expansion bolt into the hole and then knock the nail into the bolt, as shown in fig 4.1.5, and then remove the paper pattern.

NOTES!

The length of bolt depends on the installation height of the unit, bolts are field supplied.

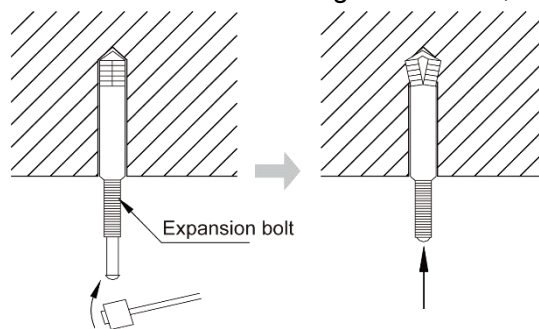

Fig 4.1.5

(2) Install the indoor unit temporarily

Assemble suspension bolt on the expansion bolt, attach the hanger bracket to the suspension bolt. Be sure to fix it securely by using a nut and washer from upper and lower sides of the hanger bracket. The washer fixing plate will prevent the washer from falling.

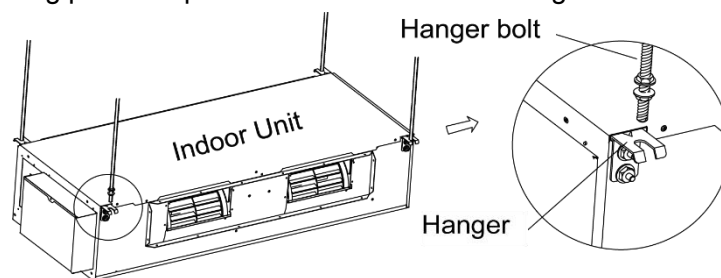

Fig 4.1.6

NOTES!

- ① Before operation, please prepare all pipelines (connection pipe, drainage hose) and wires (connection wire for wired controller, connection wire for indoor unit).
- ② When drilling holes on ceiling (air return outlet or air outlet), you can need to reinforce the ceiling to prevent vibration. For details, please consult user or builder.
- ③ If the strength of the ceiling is not good, please install a beam bracket, and then put the unit on the beam bracket.

- (3) Adjust the unit to the right position.
- (4) Check the level of the unit

The indoor unit is equipped with build-in water pump and float switch, verify the levelness of 4 directions by level gauge or vinyl tube (filled with water) respectively.

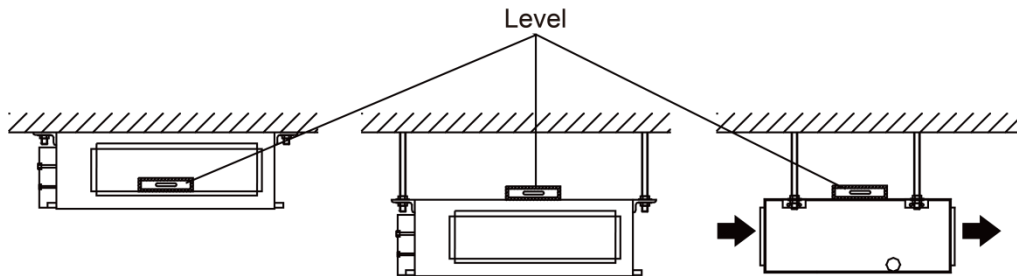
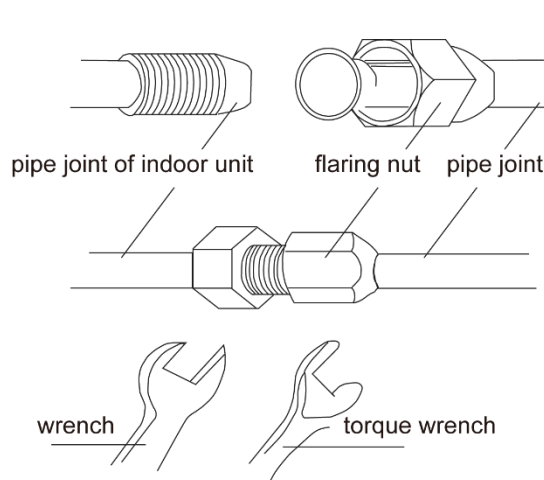

Fig 4.1.7

- (5) Remove the washer locating plate and then tighten the nut on it.

4.2 Refrigerant Pipe Connection

- (1) Aim the flaring port of copper pipe at the center of screwed joint and then tighten the flaring nut with hand as shown in fig 4.2.
- (2) Tighten the flaring nut with torque wrench.



Torque for tightening nut

Pipe diameter (mm)	Torque (N-m)
Φ6.35	15-30
Φ9.52	35-40
Φ15.9	60-65
Φ19.05	70-75

Fig.4.2

- (3) Use pipe bend when bending the pipe and the bending angle should not be too small.
- (4) Wrap the connection pipe and joint with sponge and then tie them firmly with tape.

4.3 Drainage Pipe Installation and Drainage System Testing

4.3.1 Notice for Installation of Drain Pipe

- (1) The drainage pipe should be short and the gradient downwards should be at least 1%~2% in order to drain condensation water smoothly.
- (2) The diameter of drainage hose should be bigger or equal to the diameter of drainage pipe joint.
- (3) Install drainage pipe according to the following fig and arrange insulation to the drainage

pipe. Improper installation may lead to water leakage and damp the furniture and other things in the room.

- (4) You can buy normal hard PVC pipe used as the drainage pipe. During connection, insert the end of PVC pipe into the drainage hole and then tighten it with drainage hole and wire binder. Can't connect the drainage hole and drainage hole with glue.
- (5) When the drainage pipelines are used for several units, the position of pipeline should be about 100mm lower than the drainage port of each unit. In this case, thicker pipes should be applied.

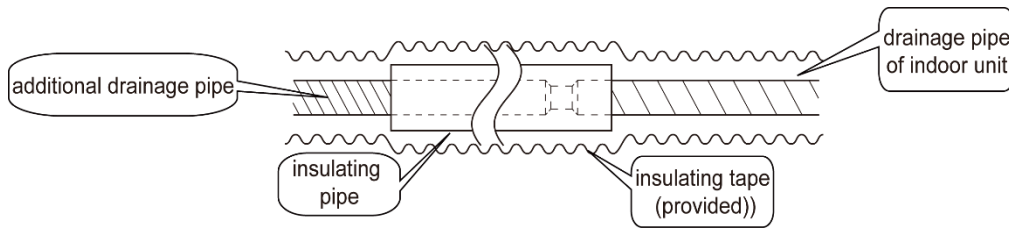

Fig 4.3.1

4.3.2 Drainage Pipe Installation

- (1) Insert the drain hose into the drain hole and tighten it with tapes, as shown in Fig 4.3.2.
- (2) Tighten the pipe clamp, with the distance between screw nut and hose smaller than 4mm.
 - ① metal clamp(accessory)
 - ② drain hose(accessory)
- (3) Use sealing plate to make the pipe clamp and hose insulated, as shown in Fig.4.3.3.
 - ① metal clamp(accessory)
 - ② thermal sponge(accessory)

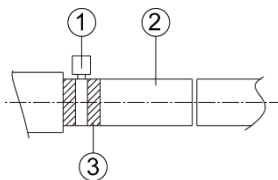

Fig 4.3.2

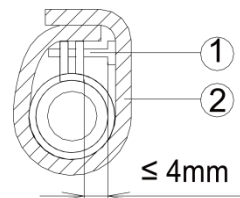

Fig 4.3.3

- (4) When connecting several drain pipes, follow the instruction as indicated in Fig 4.3.4. Choose the drain collecting pipe that matches with unit capacity.

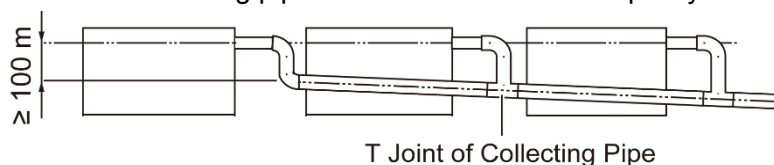

Fig 4.3.4

- (5) Install the trap as shown in following Fig 4.3.5.
- (6) Install one trap for each unit.
- (7) Convenience for cleaning trap in the future should be considered when installing it.

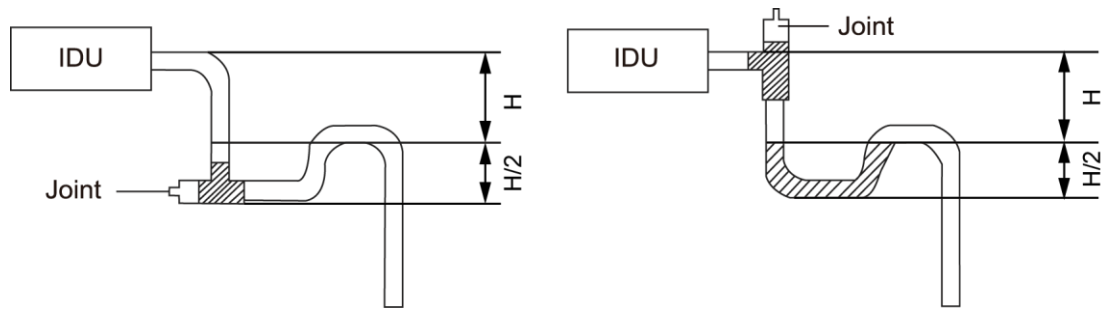

Fig 4.3.5

(8) The horizontal pipe can be connected to vertical pipe in the same level; please select the connection way as shown in following fig.

NO1: Connection of drainage pipe joints (Fig4.3.6)

NO2: Connection of downspout elbow (Fig4.3.7)

NO3: Inserting pipe connection (Fig4.3.8)

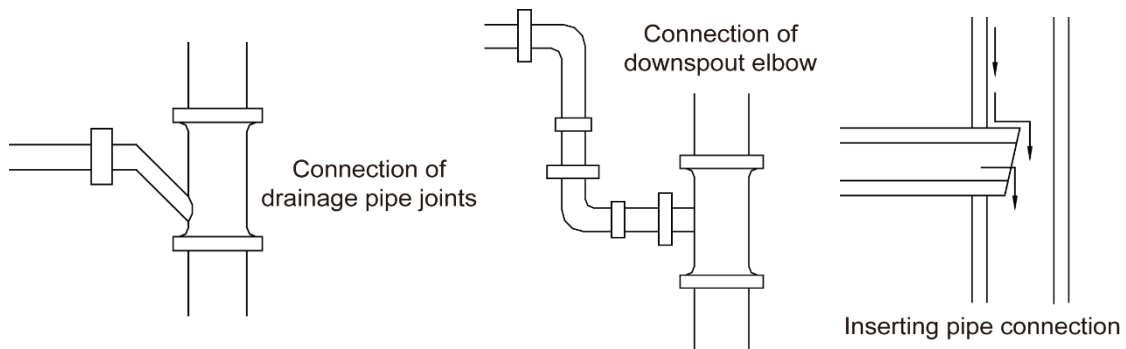

Fig 4.3.6

Fig 4.3.7

Fig 4.3.8

(9) The installation height of raising pipe for drainage should be lower than B. The gradient from raising pipe towards drainage direction should be at least 1%~2%. If the raising pipe is vertical with the unit, the raising height should be less than C.

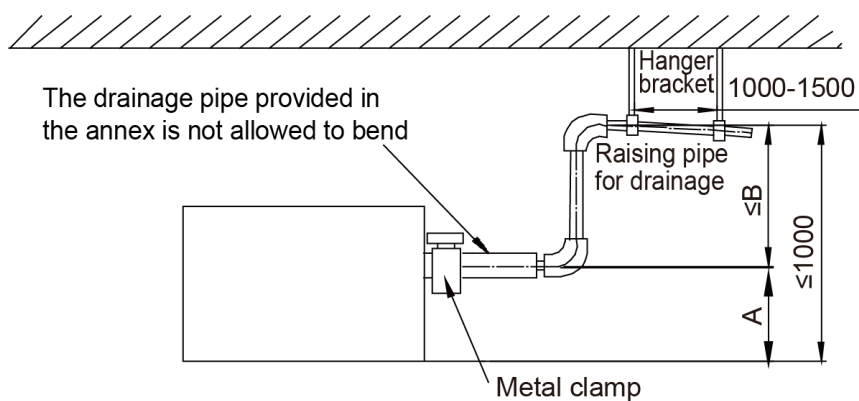

Fig 4.3.9

model	A(mm)	B(mm)	C(mm)
ATMI-160VRDC1A	150	850	800

(10) Drain pipes should have a downward slope of at least 1%~2%, in order to prevent pipes from sagging, install hanger bracket at intervals of 1000~1500 mm.

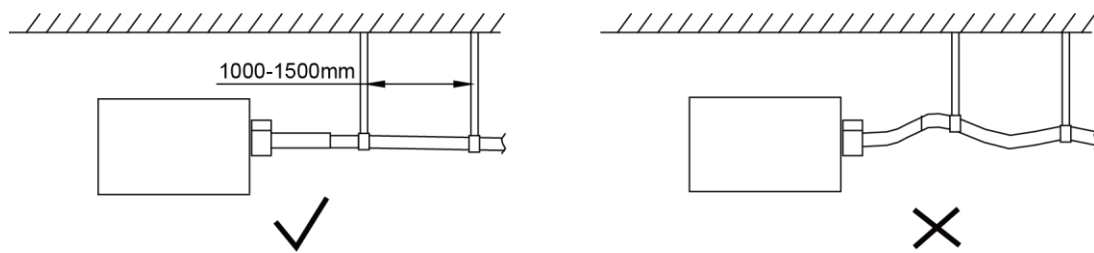

Fig 4.3.10

4.3.3 Test of Drainage System

(1) Please test drainage system after electric work is finished.

Inject approximately 1L purified water to drain pan from air vent, ensure that not to splash the water over the electrical components (e.g. water pump. etc.).

- 1) Spray 1L water on evaporator with sprayer.
 - 2) In case of commissioning finished, please energize the IDUs and switch to cooling or dry mode, meanwhile, the water pump operates, you can check the draining through the transparent part of drain socket.
 - 3) If communication wire is not connected, communication malfunction “C0” will occur after 60s of energizing. In this case, the water pump operates automatically. Check if the water pump drains normally through drainage port. The water pump will stop automatically after running for 10min.
- (2) During the test, please carefully check the drainage joint, make sure no any leakage occur.
- (3) It is strongly recommend to do the drain test before ceiling decoration.

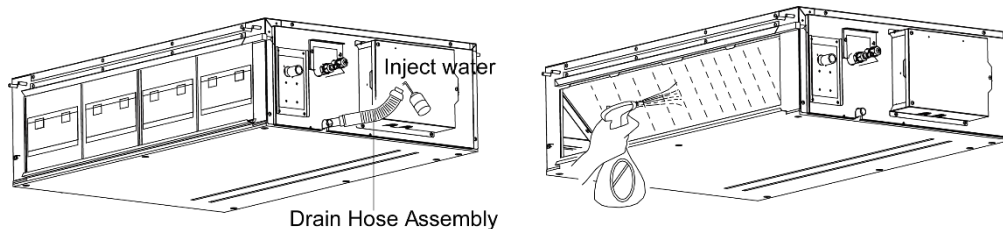

Fig 4.3.11

4.4 Installation of Air Duct

! NOTES!

- ① There should be insulating layer on air-out duct, air-return duct and fresh air duct to avoid heat loss and moisture. Adhere a nail on the air duct and then add thermal sponge with a layer of tin. Fasten it with a nail cover and then seal the junction with tin tapes. You can also use other materials that have good insulation quality.
- ② Each air-out duct and air-return duct should be fixed on a pre-made board with iron frame. The junction of air duct should be well-sealed in order to prevent air leakage.
- ③ The design and construction of air duct should comply with national requirements.
- ④ The edge of air-return duct is suggested to be more than 150mm away from the wall. Add a filter to the air-return opening.
- ⑤ Please consider noise-damping and vibration damping for the design and construction of air duct. Besides, noise source must be away from people. For instance, do not have the air-return opening installed on top of the user (Offices, rest area, etc.).

4.4.1 Installation of Air-out Duct

(1) Installation of the Rectangular Duct

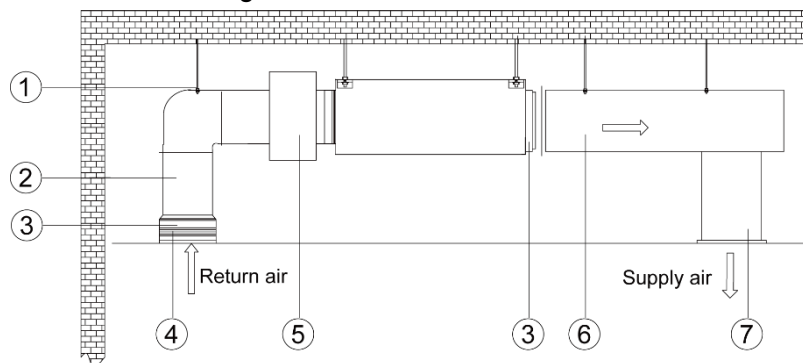

Fig 4.4.1

No.	Name	No.	Name
1	Hanger Rod	5	Static Pressure Box
2	Return Air Duct	6	Main Supply Air Duct
3	Canvas Duct	7	Supply Air Outlet
4	Return Air Inlet		

4.4.2 Shape and Size of Air Outlet and Air Intlet

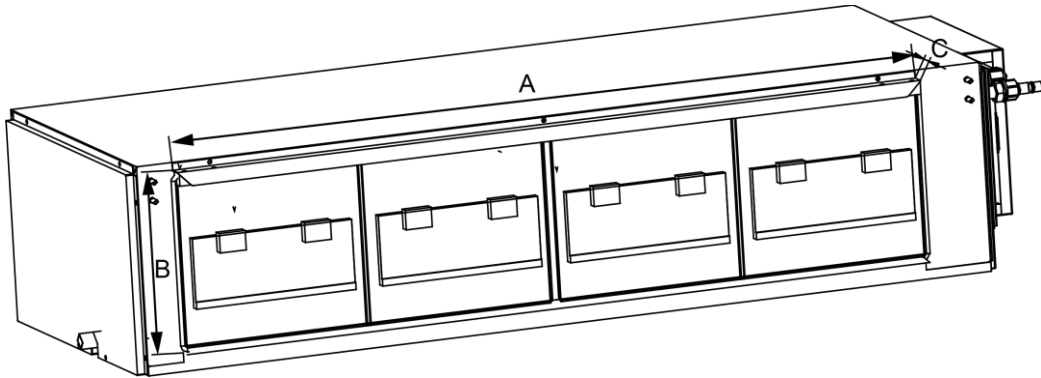

Fig 4.4.2 Air Intlet

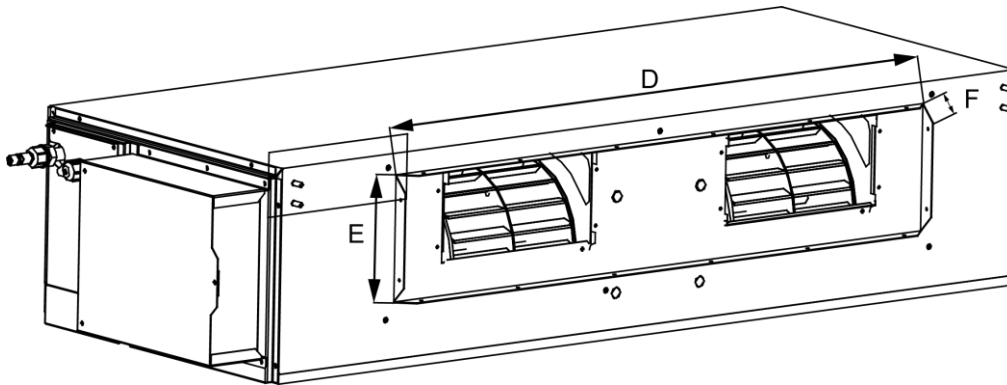

Fig 4.4.3 Air Outlet

Model	Intlet			Outlet		
	A	B	C	D	E	F
ATMI-160VRDC1A	953	316	12	852	190	17

4.4.3 Installation of the Return Air Duct

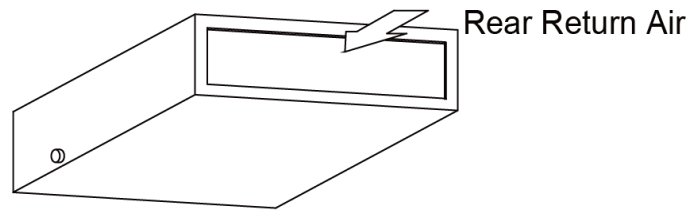

Fig 4.4.4

The installation method can be chosen with considering the conditions of the building and maintenance etc., as shown in Fig 4.4.5

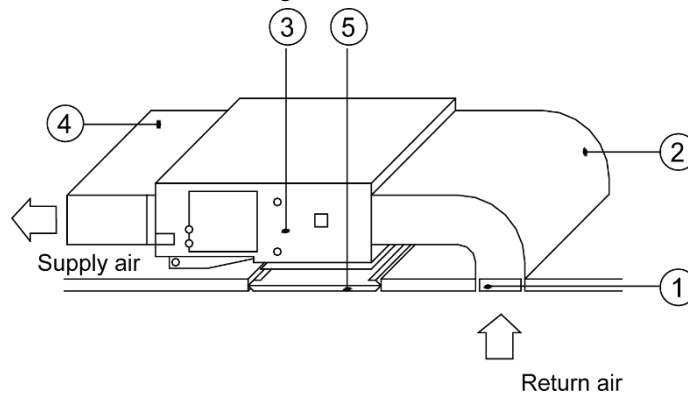

Fig 4.4.5

Table 5 Installation of the return air duct

No.	Name	No.	Name
1	Return Air Inlet (with filter)	4	Supply Air Duct
2	Return Air Duct	5	Grille
3	Indoor unit		

4.5 Installation of Wired Controller

Please refer to User Manual of Wired Controller for the installation details.

! NOTES!

When installation is finished, the unit must be tested and debugged before operation. Please refer to Instruction Manual of ODU for auto addressing and debugging details.

5 Wiring Work

! WARNING!

Before obtaining access to terminals, all supply circuits must be disconnected.

Notes:

- ① Units must be earthed securely, or it may cause electric shock.
- ② Please carefully read the wiring diagram before carry out the wiring work, incorrect wiring could cause malfunction or even damage the unit.
- ③ The unit should be powered by independent circuit and specific socket.

- ④ The wiring should be in accordance with related regulations in order to ensure the units reliable running.
- ⑤ Install circuit breaker for branch circuit according to related regulations and electrical standards.
- ⑥ Keep cable away from refrigerant pipings, compressor and fan motor.
- ⑦ The communication wires should be separated from power cord and connection wire between indoor unit and outdoor unit.
- ⑧ Adjust the static pressure via wired controller according to site circumstance.

5.1 Connection of Wire and Patch Board Terminal

- (1) The connection of wire (as shown in fig 5.1.1)
 - 1) Strip about 25mm insulation of the wire end by stripping and cutting tool.
 - 2) Remove the wiring screws on the terminal board.
 - 3) Shape the tail of wire into ring by needle nose plier, and keep the gauge of ring in accordance with screw.
 - 4) Use the screwdriver for tightening the terminal.
- (2) The connection of stranded wire (as shown in fig 5.1.2)
 - 1) Strip about 10mm insulation of the end of stranded wire by stripping and cutting tool.
 - 2) Loosen the wiring screws on terminal board.
 - 3) Insert the wire into the ring tongue terminal and tighten by crimping tool.
 - 4) Use the screwdriver for tightening the terminal.

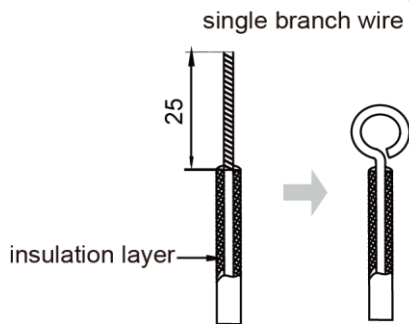

Fig 5.1.1

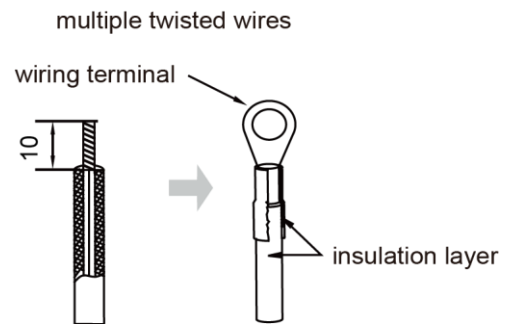

Fig 5.1.2

5.2 Power Cord Connection



WARNING!

- ① Every unit should be equipped with a circuit breaker for short-circuit and overload protection.
- ② During operation, all indoor units connected to the same outdoor unit system must be kept energized status. Otherwise, the unit can't operate normally.

Multi Variable Air Conditioners Ducted Type Indoor Unit

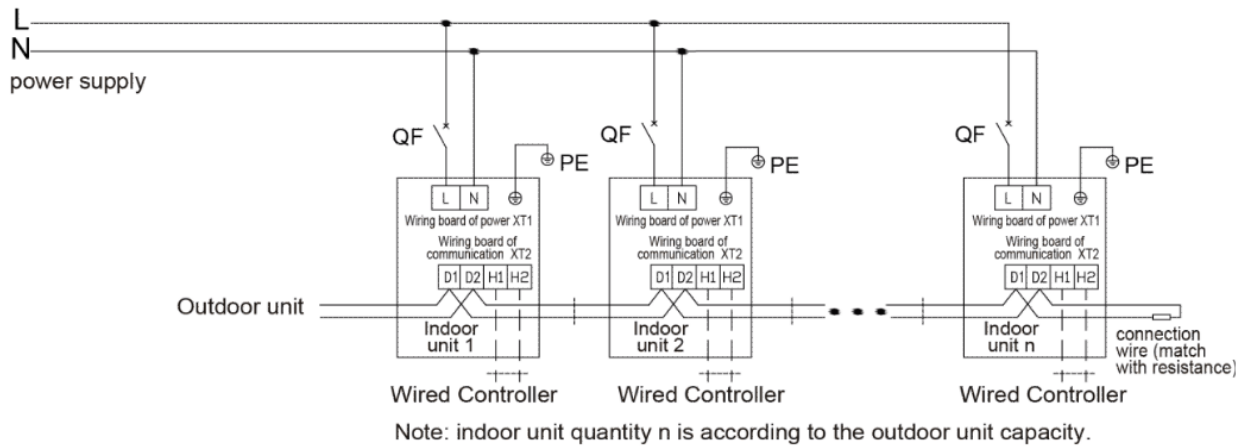

Fig 5.2

For units with single-phase power supply.

- (1) Detach the electric box lid.
- (2) Let the power cord pass through the wiring through-holes.
- (3) Connect the power cord to terminal “L, N, PE”
- (4) Fix the power card with wiring clamp.

5.3 Connection of Communication Wire between Indoor Unit and Outdoor Unit (or indoor unit)

- (1) Detach the electric box lid.
- (2) Let the Communication cable pass through the wiring through-holes.
- (3) Connect the communication wire to terminal D1 and D2 of indoor 4-bit wiring board, as shown in fig 5.3.1.

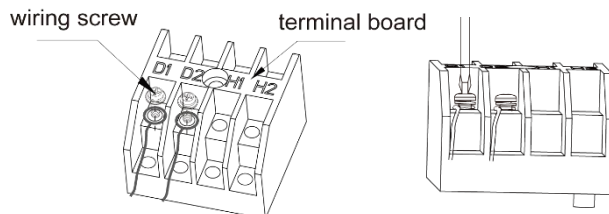

Fig 5.3.1

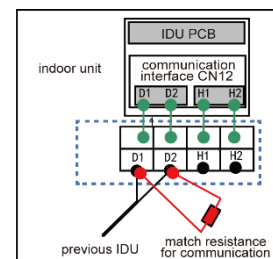

Fig 5.3.2

- (4) Fix the communication cable with clamp of electric box.
- (5) For more reliable communication, make sure connect the terminal resistor to the most downstream IDU of the communication bus (terminal D1 and D2), as shown in fig 5.3.2, terminal resistor is provided with each ODU.

5.4 Connect Communication Wire of Wired Controller

- (1) Open electric box cover of indoor unit.
- (2) Let the communication wire go through the rubber ring.
- (3) Connect the communication wire to terminal H1 and H2 of indoor 4-bit wiring board.
- (4) Fix the communication wire with wire clip on the electric box.
- (5) Wiring instructions of remote receiving light board and wired controller:
 - 1) Fig 5.4.1 shows the installation of wired controller.

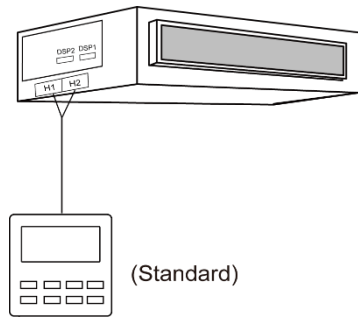

Fig 5.4.1

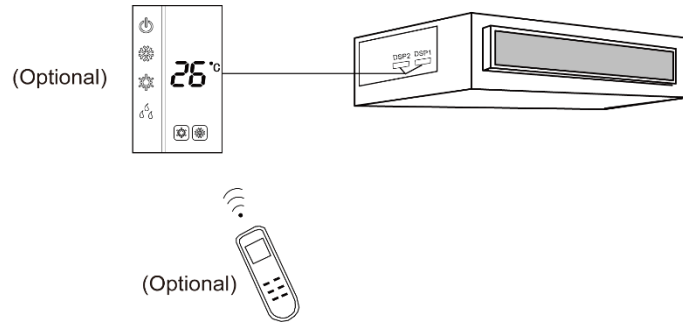

Fig 5.4.2

- 2) Fig 5.4.2 shows the installation of remote controller.
- 3) Wired controller and receiving light board can be installed at the same time. When operating through a remote controller, both wired controller and the receiving light board can receive the signals, as shown in Fig 5.4.3.

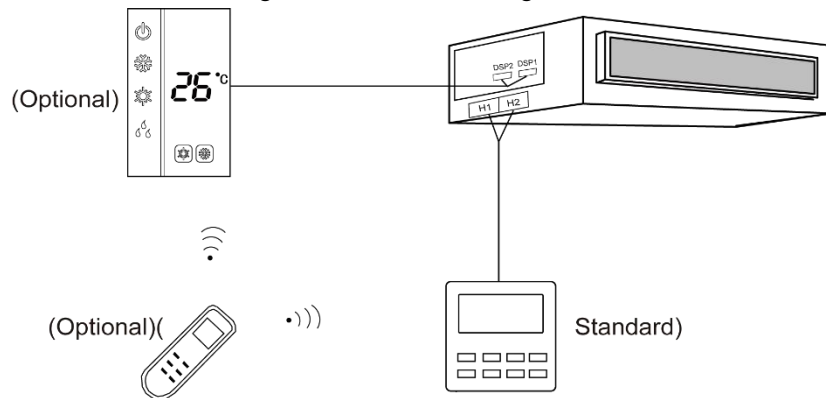

Fig 5.4.3

5.5 Illuminate for Connection of Wired Controller and Indoor Units Network

- (1) Communication wire of indoor unit and outdoor unit (or indoor unit) is connected to D1, D2.
- (2) Wired controller is connected to H1, H2.
- (3) One indoor unit can connect two wired controllers that must be set as master one and slave one.
- (4) One wired controller can control 16 indoor units in maximum at the same time. (As shown in fig5.5)

! NOTES!

- ① The type of indoor units must be the same if they are controlled by the same wired controller.
- ② When the indoor unit is controlled by two wired controllers, the addresses of the two wired controllers should be different through address setting. Address 1 is for main controller; Address 2 is for slave controller. Detailed setting please refer to the instruction manual of wired controller.

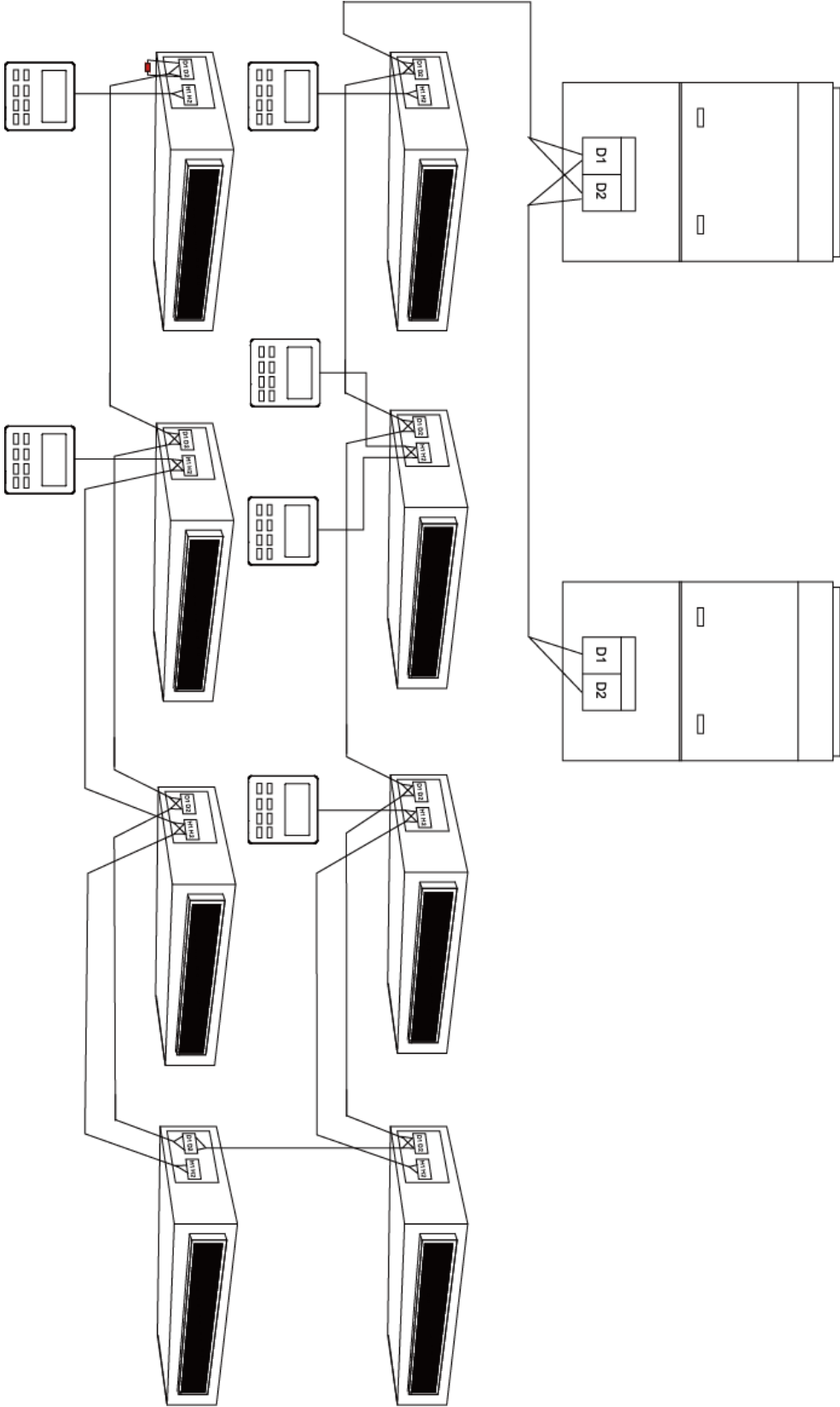

Fig 5.5

6 Routine Maintenance



WARNING!

- ① Do not turn off the unit and cut off the main power supply when cleaning the air conditioner to avoid electric shock or injury.
- ② Stand at solid table when cleaning the unit.
- ③ Do not clean the unit with hot water whose temperature is higher than 45°C to prevent fade or deformation.
- ④ Do not dry the filters by fire, or it may catch fire or become deformed.
- ⑤ Clean the filter with a wet cloth dipped in neutral detergent.
- ⑥ Please contact after-sales service staff if there is abnormal situation.

6.1 Cleaning of Filter

- (1) Remove the filters from inlet of IDU. Use a vacuum cleaner to remove dust. If the filters are dirty, wash them with warm water and mild detergent, and dry the filters in the shade.
- (2) If the unit used in the environment with much dust, please clean it regularly. (Usually once every two weeks).

6.2 Maintenance before the Seasonal Use

- (1) Check if the air inlet and air outlet of indoor and outdoor unit are blocked.
- (2) Check if securely grounded.
- (3) Check if all the power cord and communication cable are securely connected.
- (4) Check if any error code displayed after energized.

6.3 Maintenance after the Seasonal Use

- (1) Set the unit in fan mode for half a day in a sunny day to dry the inner part of unit;
- (2) When the unit won't be used for a long time, please cut off power supply for energy saving; the characters on the wired controller screen will disappear after cutting off the power supply.

7 Table of Error Codes for Indoor Unit

Error Code	Content	Error Code	Content	Error Code	Content
L0	Indoor Unit Error	LA	Indoor Units Incompatibility Error	d9	Jumper Cap Error
L1	Indoor Fan Protection	LH	Low Air Quality Warning	dA	Indoor Unit Network Address Error
L2	E-heater Protection	LC	ODU-IDU Incompatibility Error	dH	Wired Controller PCB Error
L3	Water Full Protection	d1	Indoor Unit PCB Error	dC	Capacity DIP Switch Setting Error.
L4	Wired Controller Power Supply Error	d3	Ambient Temperature Sensor Error	dL	Outlet Air Temperature Sensor Error
L5	Freeze protection	d4	Inlet Pipe Temperature Sensor Error	dE	Indoor Unit CO ₂ Sensor Error
L7	No Master Indoor Unit Error	d6	Outlet Pipe Temperature Sensor Error	dy	Water Temperature Sensor Error
L8	Power Insufficiency Protection	d7	Humidity Sensor Error	C0	Communication Error
L9	Quantity Of Group Control Indoor Units Setting Error	d8	Water Temperature Error	AJ	Filter Cleaning Reminder
db	Special Code: Field Debugging Code				

8 Troubleshooting

The air conditioner is not expected to be serviced by users. Incorrect repair may cause electric shock or fire, so please contact an authorized service center for professional service. The following checks prior to contact may save your time and money.

Phenomenon	Troubleshooting
The unit can't start	<ul style="list-style-type: none"> ① Power supply is not connected. ② Circuit breaker tripping caused by leakage of electricity. ③ Input voltage is too low. ④ Defect of main PC-board.
The unit stops after running for a while.	<ul style="list-style-type: none"> ① The inlet or outlet of ODU or IDU are blocked by obstacle.
Poor cooling effect	<ul style="list-style-type: none"> ① The filter is dirty. ② Too heavy heat load of room(e.g. too many people) ③ Door or windows is open. ④ Inlet and outlet of IDU are blocked. ⑤ Setting temperature is too high. ⑥ Refrigerant is insufficient (e.g. refrigerant leakage)
Poor heating effect	<ul style="list-style-type: none"> ① The filter is dirty. ② Door or window is open. ③ Setting temperature is too low. ④ Refrigerant is insufficient (e.g. refrigerant leakage)
Indoor fan doesn't start up during heating	<ul style="list-style-type: none"> ① At starting, the IDU fan could not operate till the heat exchange become hot, for preventing delivering the cool air. ② At defrosting, the IDU fan stopped due to system switch to cooling mode. For preventing delivering the cool air, and resume operating after defrosting.

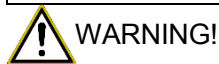

If air conditioner still fails to work normally after checking and handling as described above, please stop using it immediately and contact local service center for assistance.



66129927075